

# VMCS600

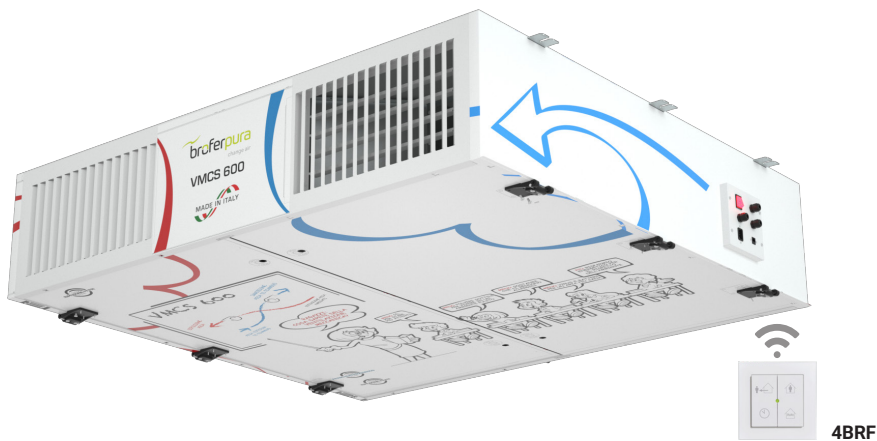

Technisches  
Datenblatt  
Data sheet



## DEZENTRALE EINHEIT VMC MIT SEHR HOHER EFFIZIENZ

**Wärmerückgewinner:** Gegenstromwärmetauscher aus Kunststoff mit sehr hoher Effizienz. Komplett mit automatischem Bypass und Kondensatauffangbehälter.

**Struktur:** selbsttragende, schalldämmende Sandwichkonstruktion. Ausgestattet mit abnehmbaren Paneelen für routinemäßige und außerordentliche Wartungsarbeiten. Komplett mit Halterungen zur Befestigung an der Decke.

**Ventilatoren:** doppelt angesaugte Radialventilatoren mit direkt gekoppeltem bürstenlosem EC-Elektromotor.

**Filter:** Effizienz G4 für die Raumluftrückführung. Effizienz M5 für die Außenluftansaugung.

### Optional:

- CO<sub>2</sub>-Kontrolle (CO<sub>2</sub>RF).
- Filter mit Effizienz F7 (VMCS600 F7).
- Modbus-Kommunikationsmodul (MODBUSRF).

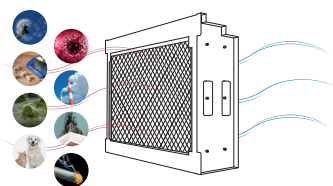

Elektronischer Filter (optional)  
Effizienz Uni 11254 und PM 2,5 90/95 %  
Electronic filter (optional)  
efficiency UNI 11254 and PM 2,5 90/95%

## DECENTRALIZED VMC HEAT RECOVERY Einhei WITH VERY HIGH EFFICIENCY

**Heat recovery:** high efficiency plastic counter-current exchanger. Complete with automatic bypass and condensate collection basin.

**Structure:** self-Halterungenng soundproof sandwich structure. Equipped with removable panels for ordinary and extraordinary maintenance operations. Complete with brackets for ceiling fixing.

**Fans:** double inlet centrifugal fans with directly coupled brushless EC electric motor.

**Filters:** G4 efficiency on return air. M5 efficiency on fresh air.

### Optional:

- CO<sub>2</sub> mittrol (CO<sub>2</sub>RF).
- F7 efficiency filter (VMCS600 F7).
- Modbus communication device (MODBUSRF).



## VMCS600 - VMCS600FE

Luftdurchsatz Erneuerung   Replacement airflow	600 mc/h
Luftdurchsatz Abluft   Extraction airflow	600 mc/h
Wärmerückgewinnungseffizienz*   Thermal recovery efficiency*	90 %
Nennleistung einzelner Ventilator (W)   Installed power single fan (w)	156
Schalldruck dB(A)   Sound pressure dB(A)	38
Luftfilterung Zuluft   Replacement air filtration	M5 ISO COARSE $\geq$ 70 %
Luftfilterung Abluft   Extraction air filtration	G4 ISO COARSE $\geq$ 65 %
Luftfilterung Zuluft (optional)   Replacement air filtration (optional)	F7 ISO und PM1 $\geq$ 65 %
Elektronische Filtration   Electronic filtration	Optional   Optional
CO <sub>2</sub> -Kontrolle   CO <sub>2</sub> mittrol	Optional   Optional

\* (UNI EN 308) Zuluft: 5 °C 72 % r. F. / Abluft: 25 °C 28 % r. F. | (UNI EN 308) fresh air: 5 °C 72% RH / expulsion air: 25 °C 28% RH

## ZEICHNUNGEN | DRAWINGS

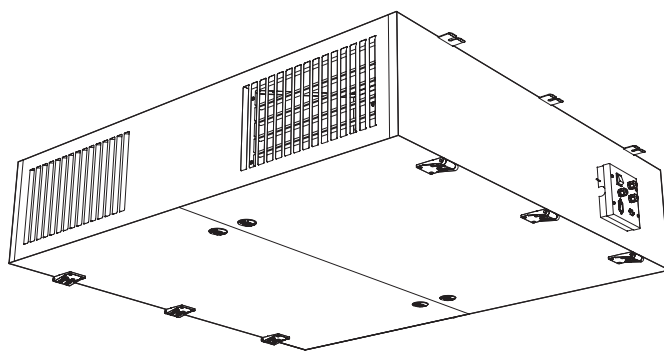

Ansicht von unten | Bottom View

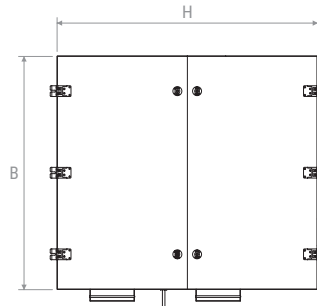

GEWICHT | WEIGHT: 170 kg

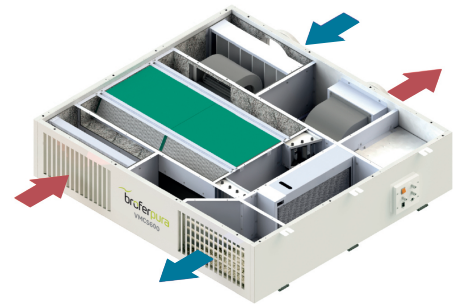

Seitenansicht DX | Side view right

Vorderansicht | Front view

Seitenansicht SX | Side view left

Rückansicht | Rear view

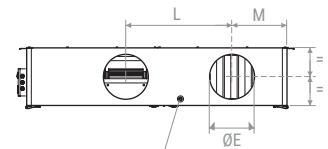
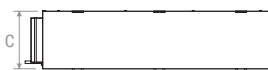
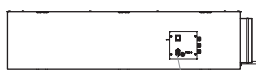

Stromversorgungseingang | Power supply input  
Controller-Anschluss | Mittroller input  
Einschalttaste | Power button

Inspektionstüren  
Inspection doors

Kondensatablauf | Mittdensate drain  
Glasrohr Ø20 | Vitreous pipe Ø20

Ansicht von oben | Top view

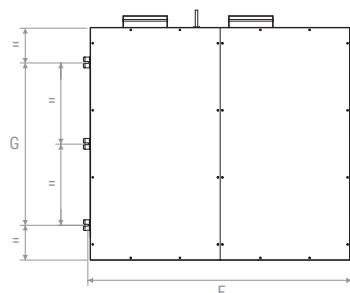

	B	H	C	ØE	F	G	L	M
mm	1300	1450	325	250	1478	910	591	307



### WÄRMETAUSCHER ZERTIFIZIERT NACH EN 308 | HEAT EXCHANGER EN 308 CERTIFIED

#### Sommerwirkungsgrad-Diagramm

Außenluft: 32 °C / 50 % R.F.  
 Raumluf: 26 °C / 50 % R.F.  
 Summer efficiency chart  
 Fresh air: 32 °C / 50 % R.H.  
 Return air: 26 °C / 50 % R.H.

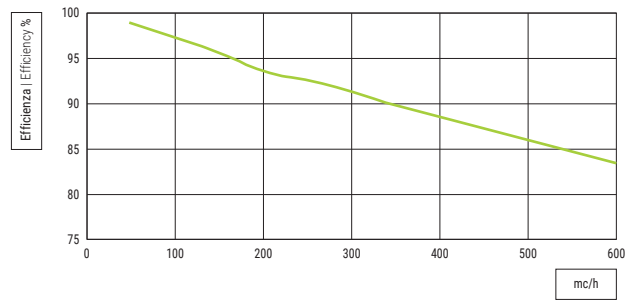

#### Winterwirkungsgrad-Diagramm

Außenluft: -5 °C / 80 % R.F.  
 Raumluf: 20 °C / 50 % R.F.  
 Winter efficiency chart  
 Fresh air: -5 °C / 80 % R.H.  
 Return air: 20 °C / 50 % R.H.

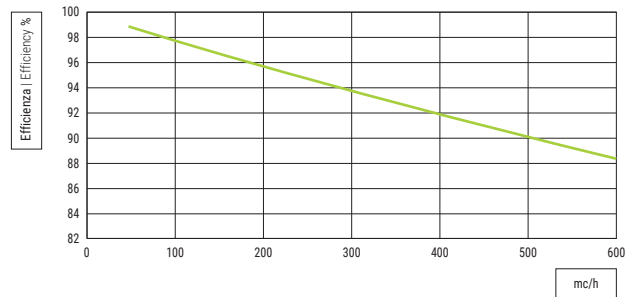

### ENTALPIE-WÄRMETAUSCHER (Temperatureffizienz) | ENTHALPIC HEAT EXCHANGER (temperature efficiency)

Außenluft: +5 °C / 70 % R.F.  
 Raumluf: 25 °C / 50 % R.F.  
 Fresh air: +5 °C / 70 % R.H.  
 Return air: 25 °C / 50 % R.H.

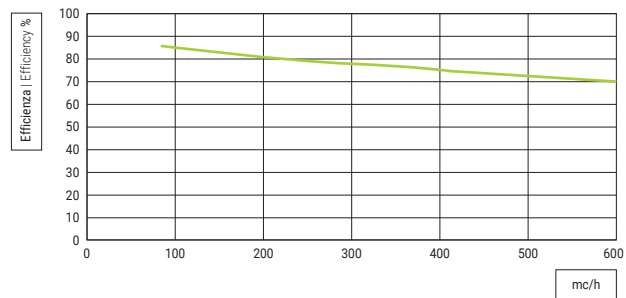

### Wärmetauscher ENTALPICO (Effizienz su umidità) | ENTHALPIC HEAT EXCHANGER (humidity efficiency)

Außenluft: +5 °C / 70 % R.F.  
 Raumluf: 25 °C / 50 % R.F.  
 Fresh air: +5 °C / 70 % R.H.  
 Return air: 25 °C / 50 % R.H.

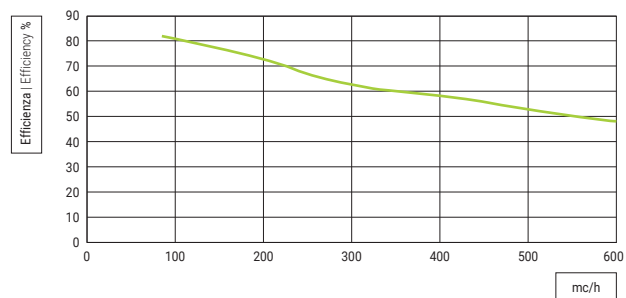

### AKUSTISCHE DATEN BEZÜGLICH DER VON DER STRUKTUR AUSGESENDETEN SCHALLLEISTUNG IRRAGGIATA DALLA STRUKTUR ACOUSTIC DATA RELATIVE TO THE SOUND POWER RADIATED BY THE CASING







	Luftdurchsatz   Air flow rate		Frequenz   Frequency								
	mc/h		Hz								
			63	125	250	500	1000	2000	4000	8000	
Hohe Geschwindigkeit   High speed	600		40	51,5	52,5	52,5	54	53,5	44	31	dB
Mittlere Geschwindigkeit   Medium speed	470		36	46,5	46,5	44	49	46	36,5	27	dB
Niedrige Geschwindigkeit   Low speed	260		24	35,5	35	33	38,5	29,5	22	18	dB



PREISE | PRICES

Modell   Model	€
<b>VMCS600</b> Standardversion   Standard version	
<b>VMCE600</b> Ausführung mit Enthalpie-Wärmetauscher   Version with enthalpic heat exchanger	
<b>VMCS600FE</b> Version mit elektronischem Filter   Version with electronic filter	
<b>VMCE600FE</b> Ausführung mit Enthalpie-Wärmetauscher und elektronischem Filter   Version with enthalpic heat exchanger and electronic filter	
<b>VMCS600G4</b> Filter Effizienz G4 (Ersatzteil)   Filter G4 efficiency (spare part)	
<b>VMCS600M5</b> Filter Effizienz M5 (Ersatzteil)   Filter M5 efficiency (spare part)	
<b>VMCS600F7</b> Filter Effizienz F7 für Zuluft   F7 efficiency filter for replacement air	

ZUSAMMENSETZUNG DER REGELSYSTEME | MitTROL SYSTEM COMPOSITION

	4BRF	RHRF	CO2RF	MODBUSRF	APPRF	DSPRF	TSMART
Modell Model							
Geschwindigkeitssteuerung Speed mittrol	•	•	•		•	•	•
By-pass						•	•
Filterverstopfung Clogged filters	•	•	•		•	•	•
Feuchtigkeitskontrolle Humidity mittrol		•					•
CO <sub>2</sub> CO <sub>2</sub> mittrol			•				•
Booster-Funktion Booster function	•	•	•		•	•	•
MODBUS-Sender MODBUS gate way				•			
Geschwindigkeitseinstellung Speeds setting		•	•			•	•
ON/OFF		•	•			•	•
Punktuelle Alarmer Punctual alarms	•	•	•			•	•
€	im Preis inbegriffen included in the price						

SCHOOL

ÖKODESIGN-DATEN | ECODSIGN DATA SHET

Modell Model	Effizienz Efficiency	Nennluftdurchsatz Nominal air flow rate	Nutzbarer statischer Druck Useful static pressure	SFPInt	SFP-2018	Frontale Geschwindigkeit Front speed	Effizienz Ventilator Fan Efficiency	Interne Leckage Internal leakage	Externe Leckage External leakage
	%	mc/h	pa	w/m <sup>3</sup> /s	w/m <sup>3</sup> /s	m/s	%	%	%
<b>VMCS600</b>	86,2	470	150	1512	1656	0,92	47,5	6,4	4,9



# VMCS600

## ZUBEHÖRE | ZUBEHÖREES

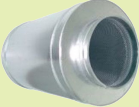
Modell   Model		€
<b>NMC160600</b>	 <p>Kompaktes Auslassmodul Frischluftansaugung aus verzinktem Blech, lackiert in RAL 9016 Compact module exhaust fresh air galvanized steel RAL 9016 painted</p>	
<b>RAVMCS600</b>	 <p>Rundschalldämpfer ohne Ogive aus verzinktem Blech Circular sound attenuator with out ogive in galvanized steel</p>	<b>RAVMCS600250</b> (250 mm)
		<b>RAVMCS600500</b> (500 mm)
		<b>RAVMCS600750</b> (750 mm)
		<b>RAVMCS6001000</b> (1000 mm)

## ANWENDUNGEN | APPLICATIONS

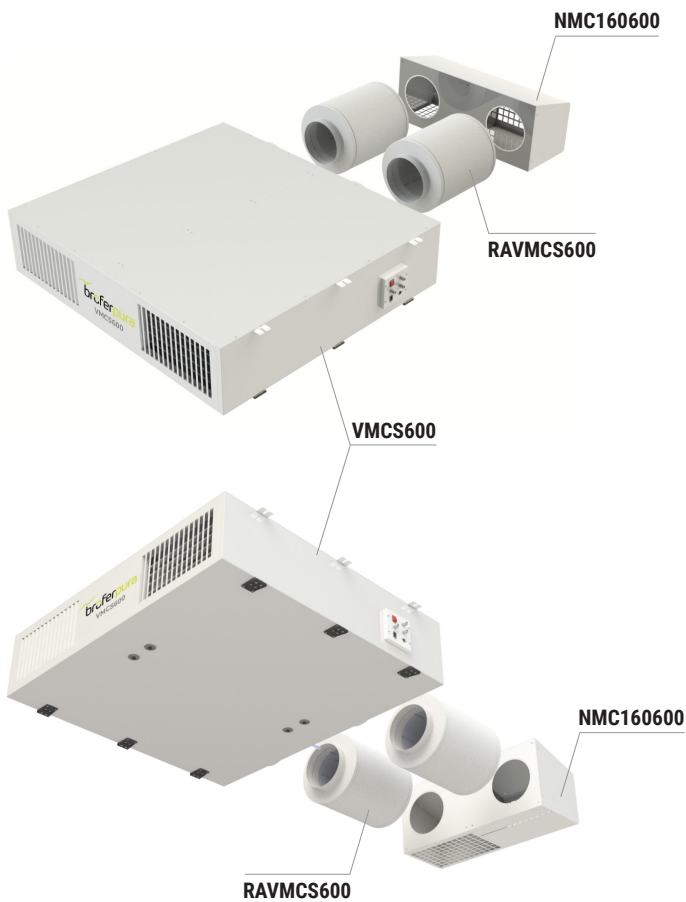

ZEICHNUNGEN | DRAWINGS

NMC160600

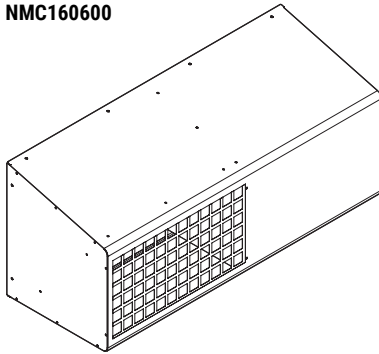

Ansicht von unten | Bottom View

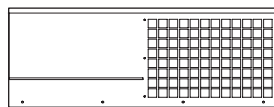

Vorderansicht | Front View

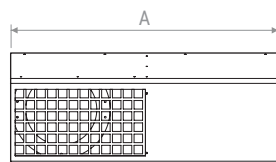

Seitenansicht | Side View

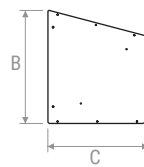

Rückansicht | Rear View

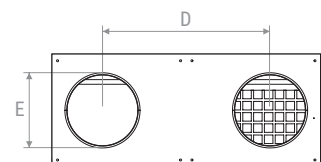

Abluftkammer  
Exhaust air compartment

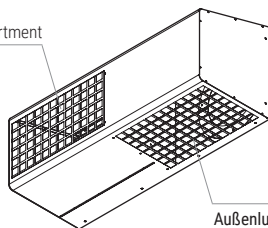

Außenluftansaugkammer  
Fresh air compartment

Auslasskanäle der Wand  
Ducts coming out of the wall

Guillotinen zur Anpassung des  
Kanalumfangs  
Guillotines for circumference  
adaption of the ducts

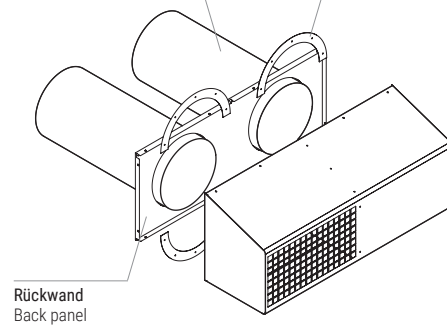

Rückwand  
Back panel

	A	B	C	D	E
mm	950	370	320	591	Ø 265

RAVMCS

Intern | Internal

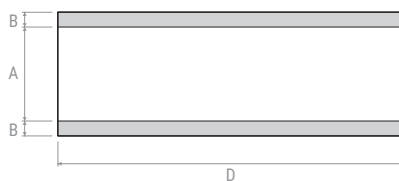

Extern | External

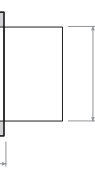

	A	B	C	D
mm	250	50	248	250 / 500 / 750 / 1000

