

ZUBEHÖRE OVALI | OVAL ZUBEHÖREES

TVMSO

Halbstarres ovales Rohr aus PE 102x50 in einer Rolle von 50 m.
Oval hose in PE 102x50 in rolls of 50 meters.



Modell Model		A	B	C	D	€ Meter meter
TVMSO	mm	92	102	39	49	

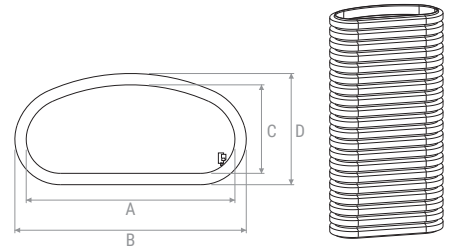

TVMS001

Kurve 90° vertikal, aus PE 102x50 / antistatisch und antibakteriell.
90° vertical curve in PE 102x50 / antistatic and antibacterial.



Modell Model	A	B	C	D	€ Stück piece
TVMS001	56±0,3	61,53	110,27	107±0,3	

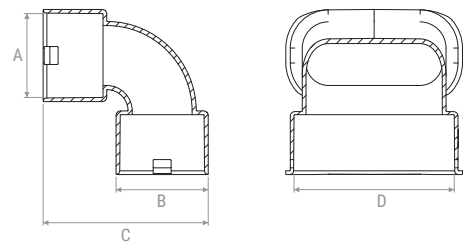

TVMS002

Kurve 90° horizontal, aus PE 102x50 / antistatisch und antibakteriell.
90° horizontal curve in PE 102x50 / antistatic and antibacterial.



Modell Model	A	B	€ Stück piece
TVMS002	164	112,18	

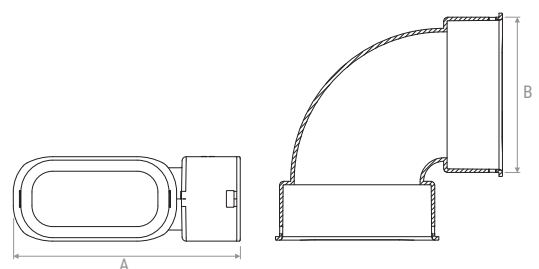

TVMS0003

90°-Adapter für halbovale Kanäle 102x50 auf Rundkanäle d.75 mm, antistatisch und antibakteriell.
 90° duct adapter for oval 102x50 to circular d.75mm antistatic and antibacterial.



Modell Model		A	B	C	€ Stück piece
TVMS0003	mm	107	119	141	

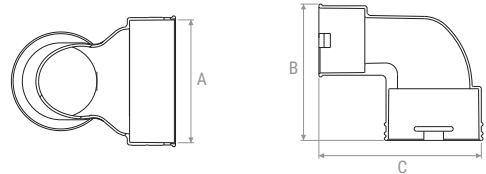

TVMS0004

Adapter DN125 +1 Verschlusskappe – 2 x seitlicher Anschluss, antistatisch und antibakteriell.
 Diameter 125mm adapter + 1 cap - 2 side mitnections for oval in PE 102x50 antistatic and antibacterial.



Modell Model		ØA	B	C	D	€ Stück piece
TVMS0004	mm	126	411	175	215	

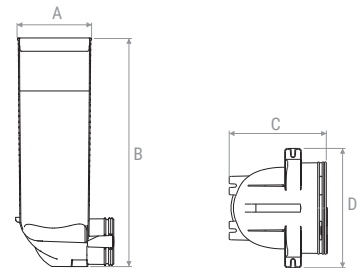

TVMS0005

Befestigungsklemme für ovales Rohr 102x50.
 Fastening for oval hose 102x50.



Modell Model		A	B	C	€ Stück piece
TVMS0005	mm	128	110	100	

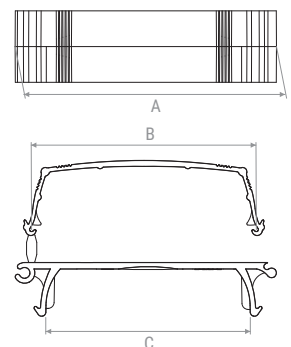

ZUBEHÖRE OVALI | OVAL ZUBEHÖREES

TVMS0006

Verbindungsstück für ovales Rohr 102x50.
Mitnector for oval hose 102x50.



Modell Model		A	B	C	D	€ Stück piece
TVMS0006	mm	112	82	61	91	

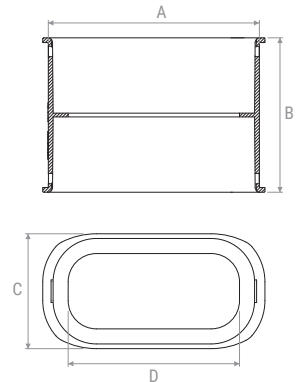

TVMS0007

Dichtungsring für ovales Rohr 102x50 (10er-Packung).
Sealing ring for oval hose 102x50 (package 10 pcs.).



Modell Model		A	B	C	D	€ Verpackung package
TVMS0007	mm	109+0,4	37	112,4±0,3	58	

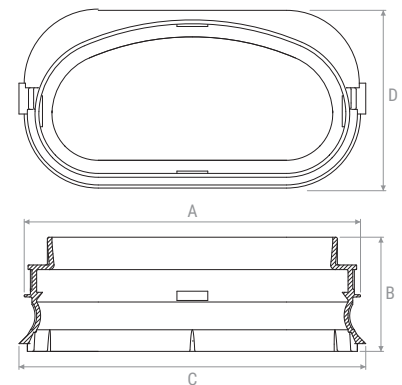

TVMS0008

Durchflussregler für TVMSO-Schlauch (10er-Packung).
Flow regulator for oval hose TVMSO (package 10 pcs.).



Modell Model		A	B	C	€ Verpackung package
TVMS0008	mm	97,3	60,4	46,3	

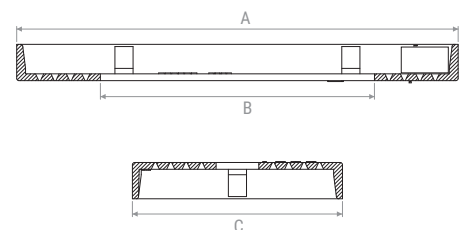

TVMS0009

Verschlusskappe für ovales Rohr 102x50.
Cap for oval hose 102x50.



Modell Model		A	B	C	€ Stück piece
TVMS0009	mm	116,7	65,7	20	

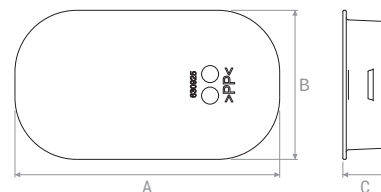

ZUBEHÖRE SPIRO | SPIRO ZUBEHÖREES

TS

Verzinktes Spiralrohr.
Galvanized sheet spiro duct.



Material verfügbar in der Brofer-Preisliste für Luftverteilung.
Material available on Brofer air diffusion price list.

