

BRK



Scheda tecnica
Data sheet



UNITÀ DI RECUPERO CALORE DI TIPO COMMERCIALE AD ALTISSIMA EFFICIENZA

BY-PASS INCLUSO

MOTORI EC CON INVERTER

INSTALLAZIONE ORIZZONTALE

Recuperatore di calore: in controcorrente interamente realizzato in alluminio. In corrispondenza dello stesso è prevista una vasca per il drenaggio della condensa.

Struttura: il telaio portante è realizzato con profili di alluminio e pannellatura sandwich afonica. Le unità sono provviste di pannelli asportabili per accedere all'interno ed effettuare le operazioni di manutenzione ordinaria e straordinaria.

Ventilatori: plug fan con motore EC Brushless (modelli BRK 1600, BRK 2400). Ventilatore centrifugo a doppia aspirazione a pale avanti con motore EC Brushless a portata costante (modello BRK900).

Filtri: le unità sono provviste di serie con celle filtranti ondulate in fibra sintetica classe G4, telaio in acciaio zincato e reti di protezione in filo di acciaio zincato elettrosaldato.

COMMERCIAL HEAT RECOVERY UNIT WITH VERY HIGH EFFICIENCY

BY-PASS INCLUDED

EC MOTORS WITH FREQUENCY CONVERTER

HORIZONTAL INSTALLATION

Heat recovery: the heat exchanger is the counterflow type all-aluminium. On the same is installed a condensate drain basin.

Structure: the frame is made of aluminium and galvanized steel sandwich sound proof panels. The units are equipped with removable panels for access to the interior and make routine and extraordinary maintenance.

Fans: plug fan with EC Brushless engine (models BRK 1600, BRK 2400). Fan centrifugal double inlet for ward blades with EC Brushless engine constant air flow (model BRK 900)

Filters: the units are equipped with standard filter cells wavy synthetic fiber efficiency G4, galvanized steel frame and safety nets in electro galvanized steel wire.



	BRK900	BRK1600	BRK2400
Portata aria (mc/h) Nominal air flow (mc/h)	900	1600	2400
Pressione statica utile (pa) Useful static pressure (pa)	100	170	90
VENTILATORE DIRETTAMENTE ACCOPPIATO (dati per singolo ventilatore) FANS (data for each fan)			
Potenza nominale (w) Installed power (W)	240	480	500
I nominale (A) Current (A)	1,8	3,6	3,8
Tensione (V) Rated voltage (V)	230	230	230
Frequenza (Hz) Frequency (HZ)	50	50	50
Velocità (nr) Speeds (nr)	1	1	1
FILTRI FILTERS			
Acrilici ondulati efficienza Corrugated acrylic efficiency	G4 ISO COARSE > 65 %		
Con temperature esterne < +2°C necessario preriscaldamento With fresh air temperature < +2°C it is necessary pre-heating			

DATI ECODESIGN | ECODESIGN DATA SHEET

Modello Model	Efficienza Efficiency	Portata aria nominale Nominal air flow	Pressione statica utile Useful static pressure	SFPInt	SFP-2018	Velocità frontale Frontal speed	Efficienza ventilatore Fan efficiency	Leakage interno Internal leakage	Leakage esterno External leakage
	%	mc/h	pa	w/m ³ /s	w/m ³ /s	m ³ /s	%	%	%
BRK900	73,2	800	230	972	1252	1,66	37	6,6	3,9
BRK1600	74,5	1300	370	1137	1270	1,63	49	7,3	5,5
BRK2400	74	2000	230	936	1226	2,08	55	7,3	5,5



PESO | WEIGHT: 100 kg

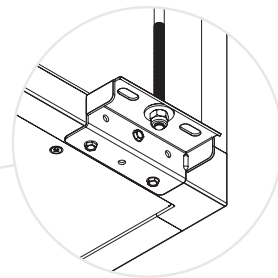
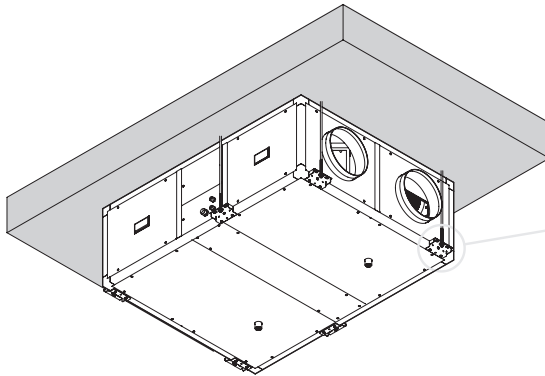

Kit staffe - Staffa di sostegno asolate Ø9 (optional)
 Kit bracket - Support bracket with slot Ø9 (optional)
SMFBRUC1000 (6 pz)

Vista dal basso | Bottom view

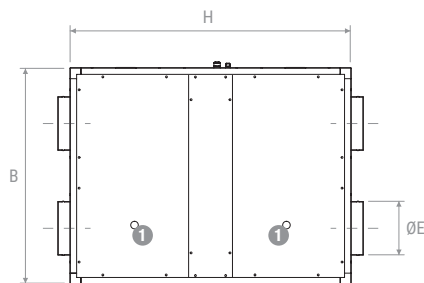

Vista frontale | Front view

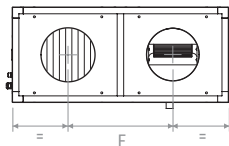

Vista laterale | Side view

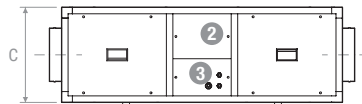

Vista posteriore | Rear view

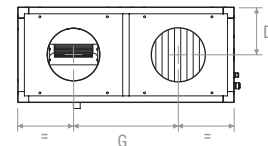

Vista dall'alto | Top view

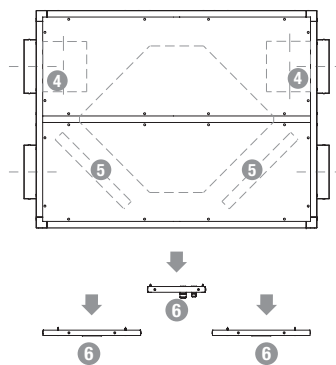

- 1 Scarico condensa | Condensed drain
- 2 Comando by pass | By pass control
- 3 Ingresso alimentazione | Power in
- 4 Ventilatore | Fan
- 5 Filtro G4 | G4 filter efficiency
- 6 Pannelli d'ispezione | Inspection panels

	H	B	C	D	ØE	F	G
mm	1300	1000	440	220	250	485	485



Pressione statica utile
Useful static pressure

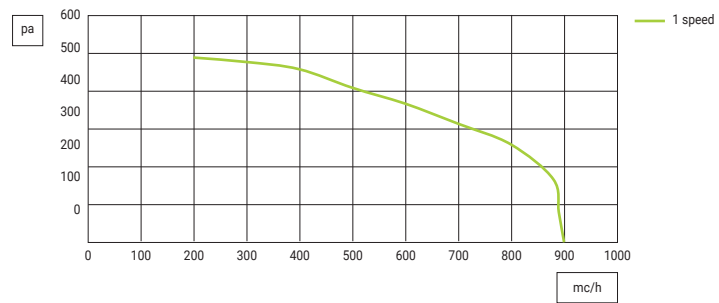

SCAMBIATORE CERTIFICATO EN 308 | HEAT EXCHANGER EN 308 CERTIFIED

Diagramma efficienza estiva

Aria esterna: 32 °C / 50 % U.R.
Aria ambiente: 26 °C / 50 % U.R.
Summer efficiency chart
Fresh air: 32 °C / 50 % R.H.
Return air: 26 °C / 50 % R.H.



Diagramma efficienza invernale

Aria esterna: -5 °C / 80 % U.R.
Aria ambiente: 20 °C / 50 % U.R.
Winter efficiency chart
Fresh air: -5 °C / 80 % R.H.
Return air: 20 °C / 50 % R.H.



PESO | WEIGHT: 155 kg

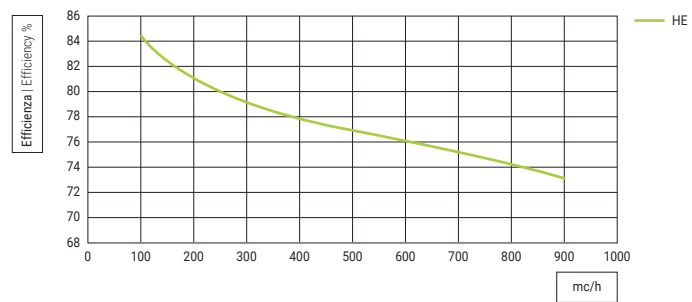
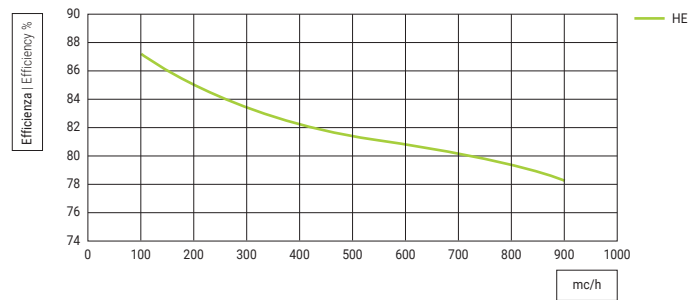
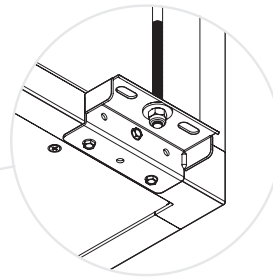
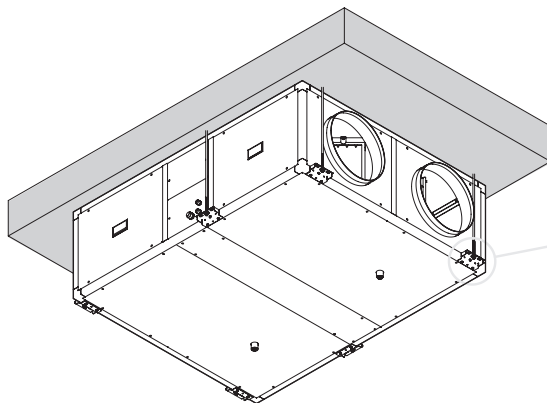

Kit staffe - Staffa di sostegno asolate Ø9 (optional)
 Kit bracket - Support bracket with slot Ø9 (optional)
SMFBRUC1000 (6 pz)

Vista dal basso | Bottom view

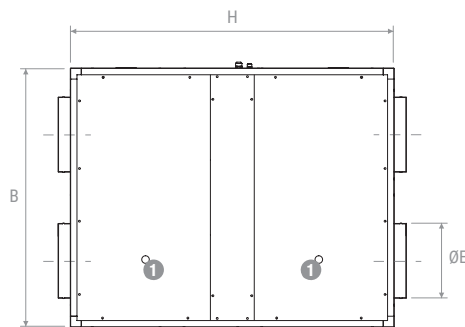

Vista frontale | Front view

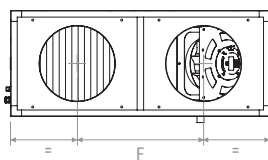

Vista laterale | Side view

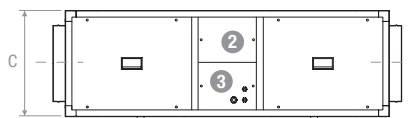

Vista posteriore | Rear view

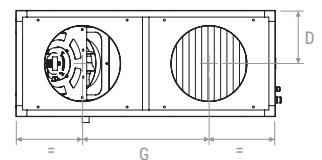

Vista dall'alto | Top view

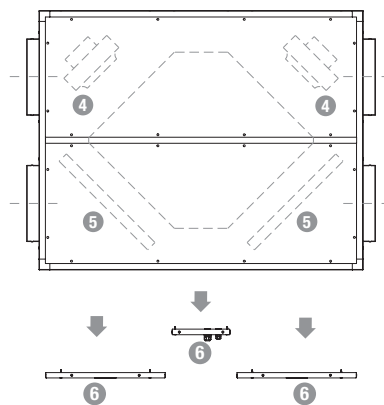

- ① Scarico condensa | Condensed drain
- ② Comando by pass | By pass control
- ③ Ingresso alimentazione | Power in
- ④ Ventilatore | Fan
- ⑤ Filtro G4 | G4 filter efficiency
- ⑥ Pannelli d'ispezione | Inspection panels

	H	B	C	D	ØE	F	G
mm	1500	1200	490	245	355	585	585



Pressione statica utile
Useful static pressure

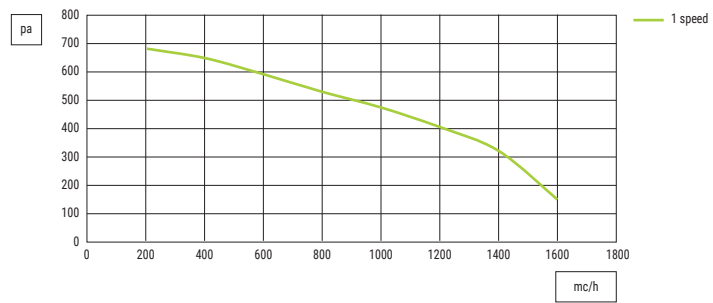

SCAMBIATORE CERTIFICATO EN 308 | HEAT EXCHANGER EN 308 CERTIFIED

Diagramma efficienza estiva

Aria esterna: 32 °C / 50 % U.R.
Aria ambiente: 26 °C / 50 % U.R.
Summer efficiency chart
Fresh air: 32 °C / 50 % R.H.
Return air: 26 °C / 50 % R.H.



Diagramma efficienza invernale

Aria esterna: -5 °C / 80 % U.R.
Aria ambiente: 20 °C / 50 % U.R.
Winter efficiency chart
Fresh air: -5 °C / 80 % R.H.
Return air: 20 °C / 50 % R.H.



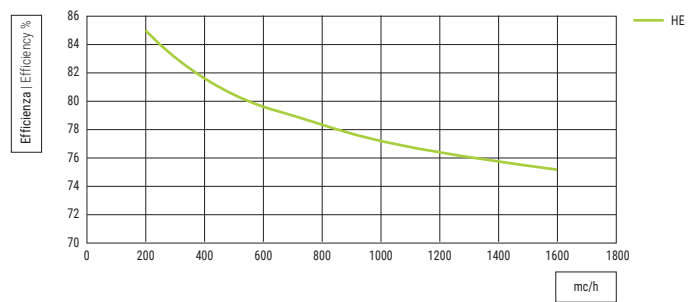
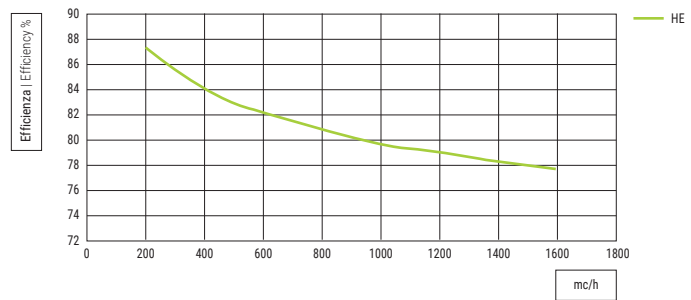
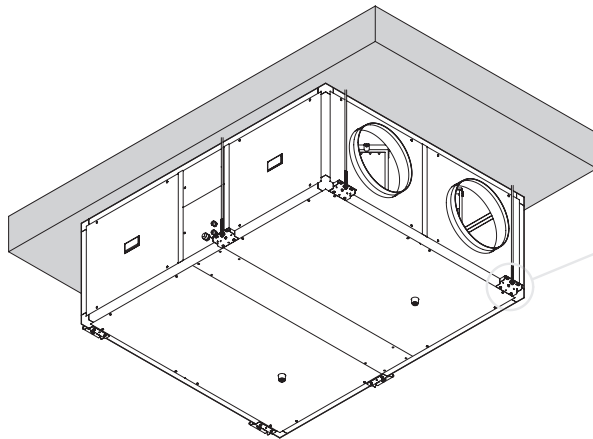

PESO | WEIGHT: **195 kg**

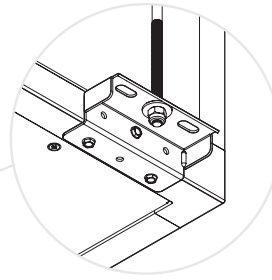

Kit staffe - Staffa di sostegno asolate Ø9 (optional)
 Kit bracket - Support bracket with slot Ø9 (optional)
SMFBRUC1000 (6 pz)

Vista dal basso | Bottom view

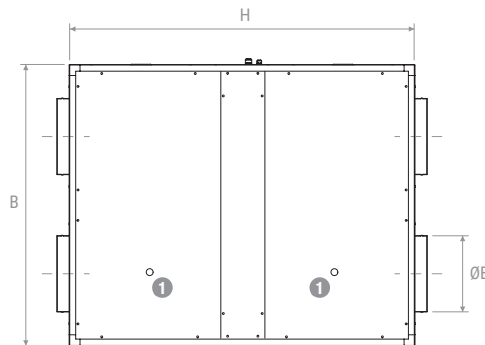

Vista frontale | Front view

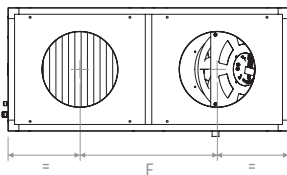

Vista laterale | Side view

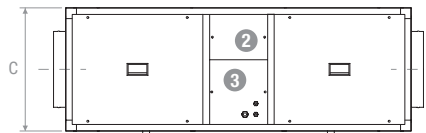

Vista posteriore | Rear view

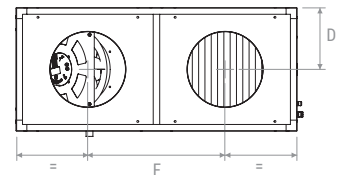

Vista dall'alto | Top view

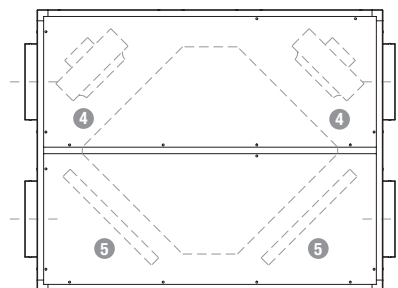

- ① Scarico condensa | Condensed drain
- ② Comando by pass | By pass control
- ③ Ingresso alimentazione | Power in
- ④ Ventilatore | Fan
- ⑤ Filtro G4 | G4 filter efficiency
- ⑥ Pannelli d'ispezione | Inspection panels

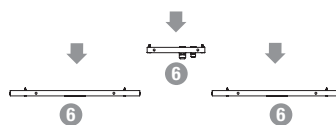

	H	B	C	D	ØE	F	G
mm	1600	1300	570	285	355	635	635



Pressione statica utile
Useful static pressure

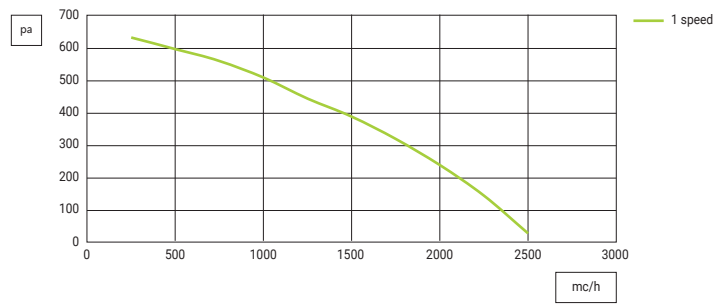

SCAMBIATORE CERTIFICATO EN 308 | HEAT EXCHANGER EN 308 CERTIFIED

Diagramma efficienza estiva

Aria esterna: 32 °C / 50 % U.R.
Aria ambiente: 26 °C / 50 % U.R.
Summer efficiency chart
Fresh air: 32 °C / 50 % R.H.
Return air: 26 °C / 50 % R.H.



Diagramma efficienza invernale

Aria esterna: - 5 °C / 80 % U.R.
Aria ambiente: 20 °C / 50 % U.R.
Winter efficiency chart
Fresh air: - 5 °C / 80 % R.H.
Return air: 20 °C / 50 % R.H.



ORIENTAMENTO VERSIONE ORIZZONTALE (vista superiore) | CONFIGURATIONS HORIZONTAL VERSION (top view)

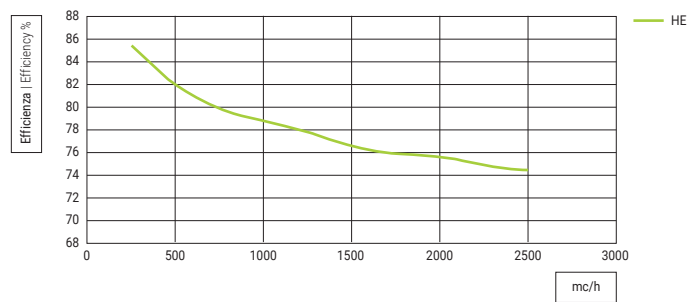
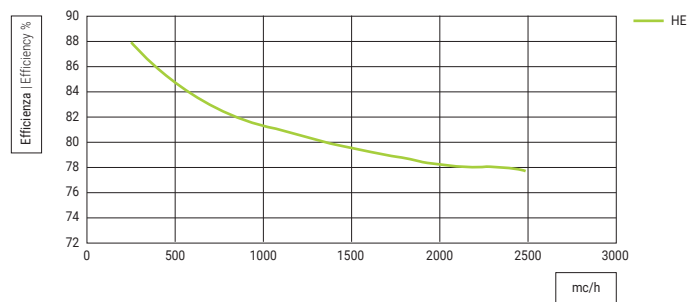
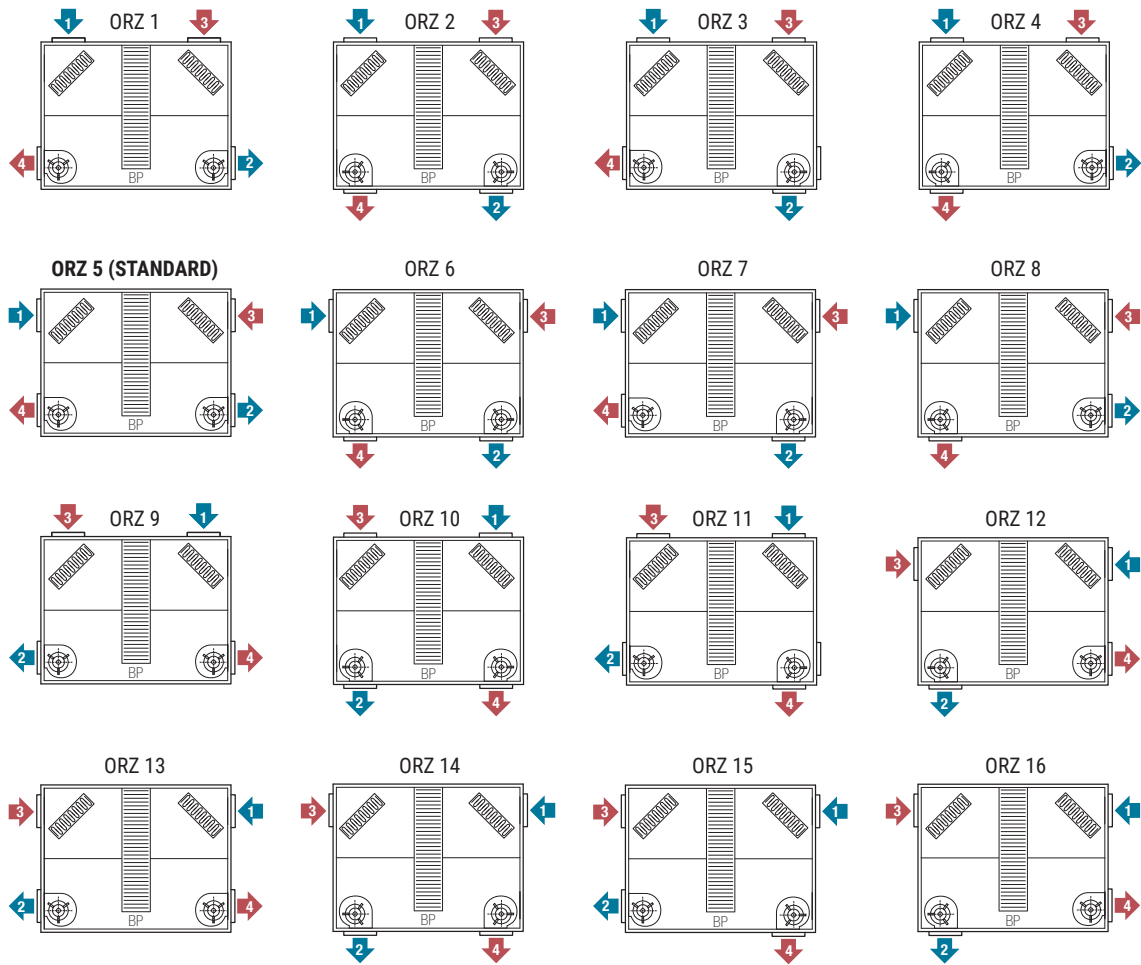

- Leggenda | Legend**
 1 = aria esterna | fresh air
 2 = mandata | supply
 3 = ripresa | return
 4 = espulsione | exhaust air



PREZZI | PRICES

Modello Model	€
BRK900BM * (1)	
BRK1600BM * (1)	
BRK2400BM * (1)	
BRK900BA ** (1)	
BKR1600BA ** (1)	
BRK2400BA ** (1)	
BRK900BAR ** (2)	
BKR1600BAR ** (2)	
BRK2400BAR ** (2)	

* By-pass manuale | Manual by-pass

** By-pass automatico | Automatic by-pass

(1) Gestibile solo con REP | Manageable only with REP

(2) Gestibile con REP e con i controlli di pagina 378-379 | Manageable with REP and with controls page 378-379

ACCESSORI | ACCESSORIES

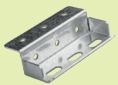
Modello Model	€
REP 	Regolatore velocità Speed control Consigliati 2 regolatori di velocità per unità Recommended 2 speed controls for unit
SMFBRUC1000 	Kit staffe per installazione a soffitto Kit brackets for ceiling mounting



GRUPPO POST TRATTAMENTO ESTIVO | SUMMER COOLING GROUP

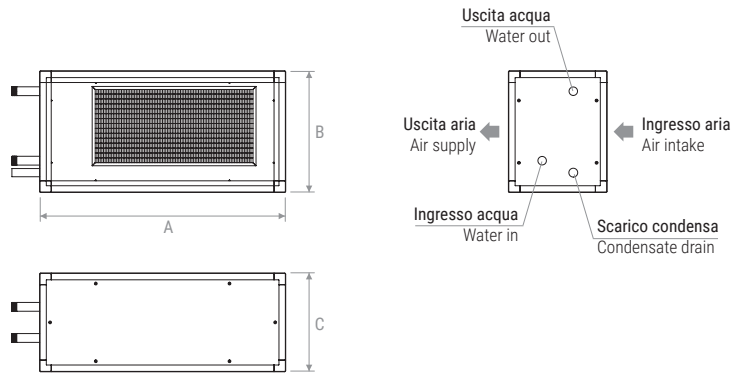

Aria ingresso: 29,5°C - 65% U.R. / Acqua ingresso: 7°C / Acqua uscita: 12°C Air inlet: 29,5°C - 65% U.R. / Water in: 7°C / Water out: 12°C											Dimensioni Dimensions	
Modello Model	Temperatura aria uscita Exit air temperature	U.R. aria uscita Exit air relative humidity	Potenzialità Capacity	Portata acqua Water flow	Perdita carico lato aria Air pressure drop	Perdita carico lato acqua Pressure drop water side	Diametro attacchi Diameter water connections	Base gruppo Base group	Altezza gruppo Height group	Spessore gruppo Thickness group	€	
	°C	%	Kw	mc/h	pa	kpa	pollici inches	A mm	B mm	C mm		
BAFREC1000	16	96	9,21	1,6	73	12,3	3/4	750	370	300		
BAFREC1500	16	96	14	2,4	66	10,6	3/4	900	430	300		
BAFREC2500	16	93	23,6	4,1	67	24,7	1	1150	490	300		

BATTERIA POST-RISCALDAMENTO ALTA TEMPERATURA | POST- HEATING HIGH TEMPERATURE COIL

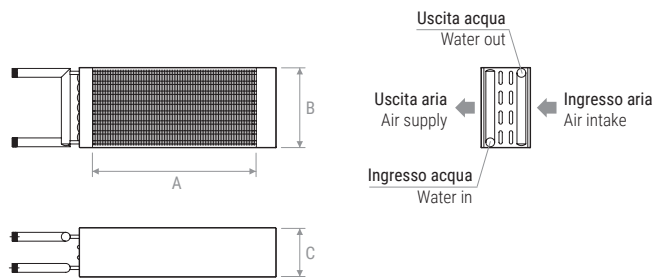

Aria ingresso: 8°C / Acqua ingresso: 70°C / Acqua uscita: 60°C Air inlet: 8°C / Water in: 70°C / Water out: 60°C											Dimensioni Dimensions	
Modello Model	Temperatura aria uscita Exit air temperature	Potenzialità Capacity	Portata acqua Water flow	Perdita carico lato aria Air pressure drop	Perdita carico lato acqua Pressure drop water side	Diametro attacchi Diameter water connections	Base passaggio aria Base air passage	Altezza passaggio aria Height air passage	Spessore Thickness	€		
	°C	Kw	mc/h	pa	kpa	pollici inches	A mm	B mm	C mm			
BRATREC1000	25	5,92	0,5	24	4,3	1/2	400	240	90			
BRATREC1500	25	8,89	0,8	22	12,8	1/2	500	300	90			
BRATREC2500	25	14,8	1,3	22	6	3/4	700	360	100			

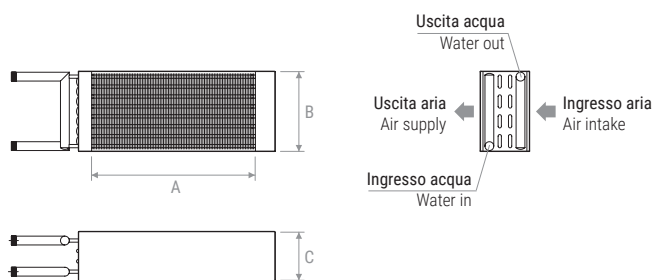

BATTERIA POST-RISCALDAMENTO BASSA TEMPERATURA | POST-HEATING LOW TEMPERATURE COIL

Aria ingresso: 8°C / Acqua ingresso: 45°C / Acqua uscita: 40°C Air inlet: 8°C / Water in: 45°C / Water out: 40°C							Dimensioni Dimensions			
Modello Model	Temperatura aria uscita Exit air temperature	Potenzialità Capacity	Portata acqua Water flow	Perdita carico lato aria Air pressure drop	Perdita carico lato acqua Pressure drop water side	Diametro attacchi Diameter water connection	Base passaggio aria Base air passage	Altezza passaggio aria Height air passage	Spessore Thickness air passage	€
	°C	Kw	mc/h	pa	kpa	pollici inches	A mm	B mm	C mm	
BRBTREC1000	30	7,67	1,3	34	7,9	3/4	500	240	150	
BRBTREC1500	30	11,5	2	30	6,4	3/4	650	300	150	
BRBTREC2500	30	19,2	3,3	30	11,5	1	900	360	160	

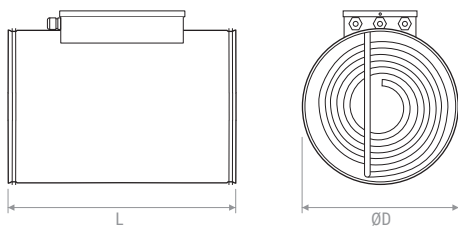
BATTERIA ELETTRICA TRIFASE | ELECTRICAL COIL 400 VOLT

Aria ingresso: 8°C / Alimentazione: 400 Volt - 50 Hz Air inlet: 8°C / Electrical data: 400 Volt - 50 Hz				Dimensioni Dimensions		
Modello Model	Temperatura aria uscita Exit air temperature	Potenzialità Capacity	Stadi Levels	Ø D Diametro Diameter	L Lunghezza Length	€
	°C	Kw	NR.	mm	mm	
BETREC1000	20	4,5	3	250	370	
BETREC1500	20	6,6	3	355	373	
BETREC2500	20	10,5	3	355	373	



BATTERIA ELETTRICA MONOFASE | ELECTRICAL COIL 230 VOLT

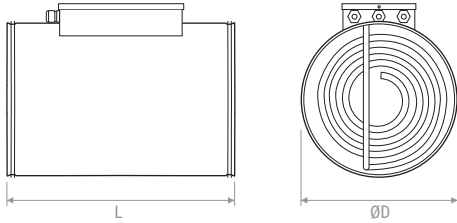

Aria ingresso: 8°C / Alimentazione: 230 Volt - 50 Hz Air inlet: 8°C / Electrical data: 230 Volt - 50 Hz				Dimensioni Dimensions		
Modello Model	Temperatura aria uscita Exit air temperature	Potenzialità Capacity	Stadi Levels	Ø D Diametro Diameter	L Lunghezza Lenght	€
	°C	Kw	NR.	mm	mm	
BEMREC1000	20	4,2	3	250	370	
BEMREC1500	20	6,3	3	355	373	
BEMREC2500	20	10,6	3	355	373	

BATTERIA ELETTRICA TRIFASE AUTOREGOLANTE | ELECTRICAL COIL 400 VOLT SELF-REGULATING

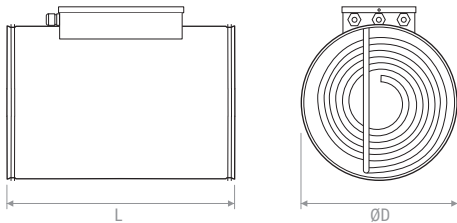

Aria ingresso: 8°C / Alimentazione: 400 Volt - 50 Hz Air inlet: 8°C / Electrical data: 400 Volt - 50 Hz			Dimensioni Dimensions	
Modello Model	Potenzialità Capacity	Ø D Diametro Diameter	L Lunghezza Lenght	€
	Kw	mm	mm	
BETREC025006000AR	6	250	370	
BETREC035509000AR	9	355	373	
BETREC035512000AR	12	355	373	

Adatte solo per funzionamento come batterie di pre-riscaldamento | Suitable only for pre-heating battery operating



BATTERIA ELETTRICA MONOFASE AUTOREGOLANTE | ELECTRICAL COIL 230 VOLT SELF-REGULATING

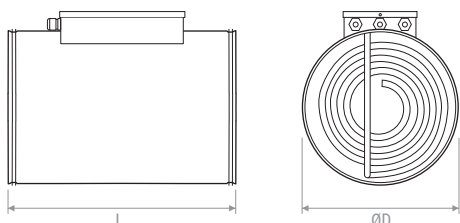

Aria ingresso: 8°C / Alimentazione: 230 Volt - 50 Hz Air inlet: 8°C / Electrical data: 230 Volt - 50 Hz		Dimensioni Dimensions		
Modello Model	Potenzialità Capacity	Ø D Diametro Diameter	L Lunghezza Length	€
	Kw	mm	mm	
BEMREC025004200AR	4,2	250	370	
BEMREC025006000AR	6	250	370	

Adatte solo per funzionamento come batterie di pre-riscaldamento | Suitable only for pre-heating battery operating

FILTRI ALTA EFFICIENZA | HIGH EFFICIENCY FILTERS

Modello Model	Efficienza Efficiency	€
GFTBRK900	F7 ISO e PM1 > 65 %	
GFTBRK1600	F7 ISO e PM1 > 65 %	
GFTBRK2400	F7 ISO e PM1 > 65 %	

Installabili nell'unità al posto dei filtri G4 di serie. Prezzo al pezzo
Installable inside the unit instead of G4 series filters. Price for pieces



SET FILTRI G4 | G4 SET FILTER

Modello Model	Efficienza Efficiency	€
FABRK900	G4 ISO COARSE > 65 %	
FABRK1600	G4 ISO COARSE > 65 %	
FABRK2400	G4 ISO COARSE > 65 %	

Prezzo per set di 2 filtri | Price for set of 2 filters



SISTEMA DI REGOLAZIONE BASE | BASIC CONTROL SYSTEM

	 CTRDSPRF	 CTRSMART
Controllo velocità Speed control	•	•
Controllo by-pass By-pass control	•	•
Intasamento filtri Clogging filter	•	•
Comunicazione MODBUS 485 MODBUS485 communication	•	•
Impostazione velocità Speed setting	•	•
ON/OFF	•	•
Allarmi puntuali Specific allarms	•	•
Programmazione giornaliera / settimanale Daily / weekly programming timer	•	•
Controllo velocità ventilatori da sonda CO ₂ posta a display Fan control speed from CO ₂ probe installed on display		•
Controllo velocità ventilatori da sonda umidità posta a display Control fan speed from humidity probe installed on display		•
Connessione wi-fi network Connection to wi-fi network		•

Le protezioni elettriche per i componenti di potenza posti all'interno delle unità sono a carico dell'installatore secondo le leggi dei singoli paesi.
Electrical protections for power components inside the units are the responsibility of the installer according to the laws of the each countries.

SISTEMA DI REGOLAZIONE AVANZATI | ADVANCED CONTROL SYSTEM

CTRBTRI (sistema controllo batteria idronica) | (hydronic coil control system)

- Controllo temperatura a punto fisso in mandata | Fixed point temperature control in supply
- Selezione stagione | Season selection

CTRBTRE (sistema controllo batteria elettrica) | (electric battery control system)

- Controllo temperatura a punto fisso in mandata | Fixed point temperature control in supply
- Segnale attivazione batteria | coil activation signal

CTRRH (sistema controllo in funzione della U.R.) con sonda interna unità | (control system in function of R.H.) with probe internal unit

- Controllo velocità ventilatori da R.H. solo per CTRDSPRF | Control fan speed by R.H. only for CTRDSPRF

CTRCO2 (sistema controllo in funzione della CO₂) con sonda posta in ambiente | (control system in function of CO₂) with probe installed in the room





- Controllo velocità ventilatori da CO₂ solo per CTRDSPRF | Control fan speed by CO₂ only for CTRDSPRF

CTRBTRI e CTRBRE non possono essere gestiti in contemporanea | CTRBTRI and CTRBRE cannot be managed simultaneously
CTRRH e CTRCO2 non possono essere gestiti in contemporanea | CTRRH and CTRCO2 cannot be managed simultaneously



COMPOSIZIONE SISTEMI DI REGOLAZIONE | CONTROL SYSTEMS COMPOSITION

Modello Model	Elenco componenti List of components	€
CTRDSPRF	Scheda elettronica PCB Sonde temperatura interne Internal temperature probes Cablaggio e collaudo sistema Wiring and system commissioning Pannello di comando remoto wireless Wireless remote control panel	
CTRSMART	Scheda elettronica PCB Sonde temperatura interne Internal temperature probes Cablaggio e collaudo sistema Wiring and system commissioning Pannello di comando remoto wireless touch screen Wireless remote control panel touch screen	

Modello Model	Elenco componenti List of components	€
CTRBTRI	 Valvola a 3 vie 3-way valve Servomotore controllo valvola Valve control servomotor Sonda temperatura da canale Duct temperature probe Cablaggio e collaudo sistema Wiring and system commissioning	
CTRBTRE	 Modulo segnale controllo Q.E. potenza batteria elettrica Control signal module Q.E. battery power electric Sonda temperatura da canale Duct temperature probe Cablaggio e collaudo sistema Wiring and system commissioning	
CTRRH	 Modulo controllo U.R. Control module R.H. Sonda U.R. interna unità Internal R.H.. probe unit Cablaggio e collaudo sistema Wiring and system commissioning	
CTRCO2	 Modulo controllo CO ₂ Control module CO ₂ Modulo rilevazione CO ₂ ambiental wireless Wireless ambient CO ₂ detection module Cablaggio e collaudo sistema Wiring and system commissioning	

CTRBTRE per funzionare deve essere accoppiato ad un quadro di potenza (vedi sotto BRUCQE) che può anche essere eseguito dall'installatore elettrico su schema Brofer.
To function CTRBTRE must be coupled to a power panel (see below BRUCQE) which can also be made by the electrical installer on the Brofer scheme

QUADRO ELETTRICO POTENZA BATTERIE ELETTRICA | POWER ELECTRIC BOX ELECTRIC BATTERY

Modello Model	Kw	€
BRUCQE45	4,5	
BRUCQE66	6,6	
BRUCQE105	10,5	
BRUCQE150	15	

