

RD25SKHE

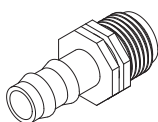

Scheda tecnica
Data sheet



Predisposizione per scarico della condensa.
Predisposition for condensate drying.



UNITÀ DI RECUPERO CALORE DOMESTICA CENTRALIZZATA AD ALTISSIMA EFFICIENZA CON SCAMBIATORE EN TALPICO REGOLAZIONE PLUG AND PLAY WIRELESS INCLUSA BY-PASS AUTOMATICO INCLUSA INSTALLAZIONE ORIZZONTALE-VERTICALE-DESTRA-SINISTRA

Recuperatore di calore: in controcorrente interamente realizzato in materiale plastico.

Struttura: autoportante in PPE a tenuta completa di sistema estrazione filtri.

Ventilatori: plug fan con motore EC Brushless a semplice aspirazione.

Filtri: le unità sono provviste di serie con celle filtranti ondulate in fibra sintetica classe G4, in opzione filtro efficienza F7 su aria esterna.

DOMESTIC CENTRALIZED HEAT RECOVERY UNIT WITH VERY HIGH EFFICIENCY ENTHALPIC HEAT EXCHANGER WIRELESS PLUG AND PLAY CONTROL SYSTEM INCLUDED AUTOMATIC BY-PASS INCLUDED INSTALLATION HORIZONTAL-VERTICAL-RIGHT -LEFT

Heat recovery: heat exchanger of the type in countercurrent entirely made of plastic material. Version with enthalpic heat exchanger.

Structure: free standing EPP seal, complete of filters ex traction system.

Fans: plug fan with EC Brushless engine single inlet.

Filters: the units are equipped with standard filter cells synthetic fiber efficiency G4, optional F7 efficiency on fresh air.

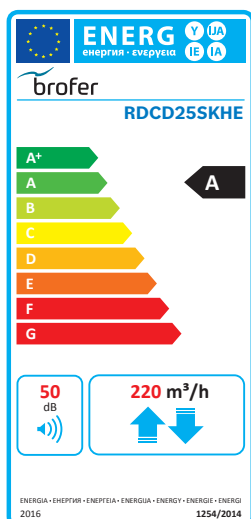

Portata aria (mc/h) Nominal air flow (mc/h)	220
Pressione statica utile (pa) Useful static pressure (pa)	100

DATI PER SINGOLO VENTILATORE | DATA FOR EACH FAN

Potenza nominale (w) Installed power (W)	50
Giri (1/min) Round (1/MIN)	4320
I nominale (A) Current (A)	0,46
Tensione (V) Rated voltage (V)	230
Frequenza (Hz) Frequency (HZ)	50
Velocità (nr) Speed (nr)	3+(1 booster)

FILTRI | FILTERS

Efficienza Efficiency Standard	G4 ISO COARSE > 65 %
Efficienza Efficiency Optional	F7 ISO e PM1 > 65 %



PESO | WEIGHT: **14 kg**

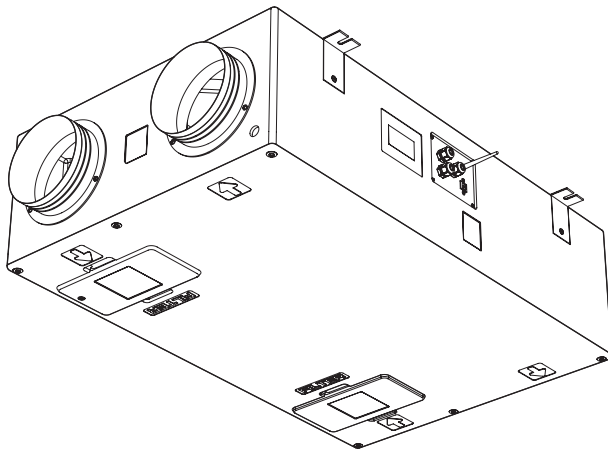

Vista dal basso | Bottom View

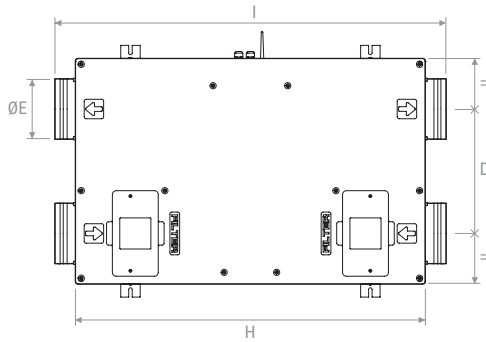

Vista interna | Internal view

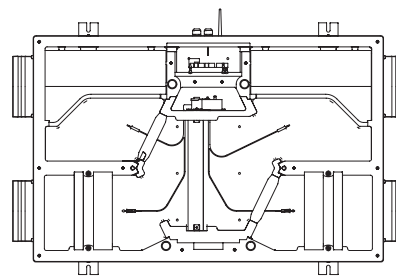

Vista laterale | Side view

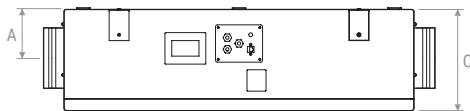

Vista frontale | Front view

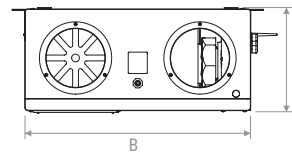

Vista in pianta | Plan view

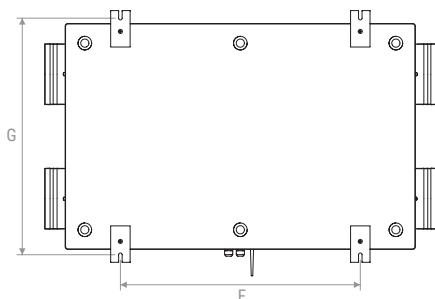

	A	B	C	D	ØE	F	G	H	I	K
mm	125	580	260	320	156	617	609	900	1005	268



DIAGRAMMI PRESTAZIONALI | PERFORMANCE CHARTS

PRESTAZIONI CERTIFICATE EN 13141:7:2011 | PERFORMANCE EN 13141:7:2011 CERTIFIED

Pressione statica utile Useful static pressure

① ③

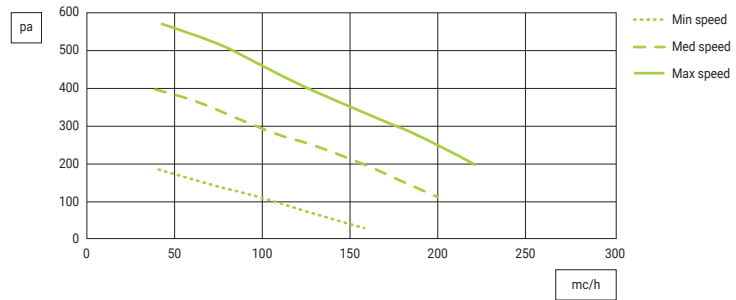

Potenza specifica ventilatore S.F.P.

②



Diagramma efficienza sensibile invernale

Aria esterna: 25 °C

Aria ambiente: 5 °C

Winter sensible efficiency chart

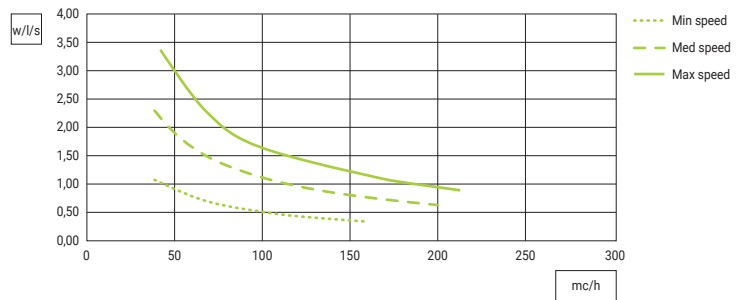
Fresh air: 25 °C

Return air: 5 °C



Diagramma efficienza latente invernale

Aria esterna: 5 °C - 79 % U.R.

Aria ambiente: 25 °C - 50 % U.R.

Winter latent efficiency chart

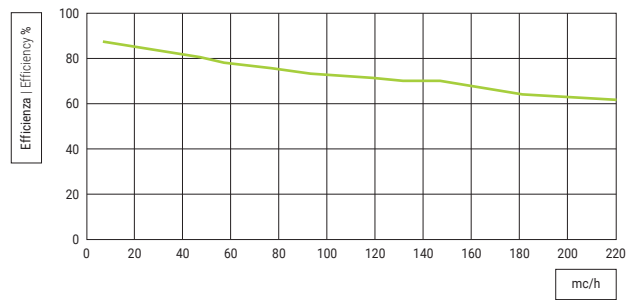
Fresh air: 5 °C - 79 % R.H.

Return air: 25 °C - 50 % R.H.

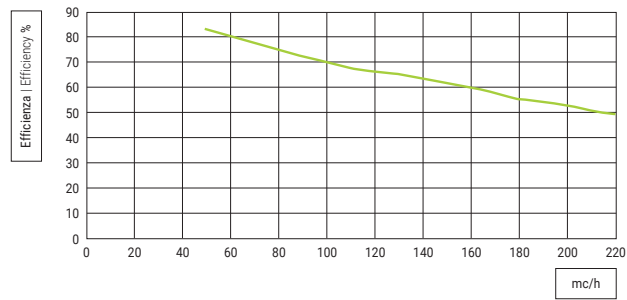

① Dati con filtri G4 standard | Data with standard G4 filters

② Dati per singolo ventilatore | Data for single fan

③ Perdite di carico filtro efficienza F7 80 pa alla massima portata con filtro pulito

Air pressure drop with F7 efficiency filter 80 pa at maximum air flow rate with clean filter



Diagramma efficienza sensibile estiva

Aria esterna: 35 °C

Aria ambiente: 25 °C

Summer sensible efficiency chart

Fresh air: 35 °C

Return air: 25 °C



Diagramma efficienza latente estiva

Aria esterna: 35 °C - 57 % U.R.

Aria ambiente: 25 °C - 50 % U.R.

Summer latent efficiency chart

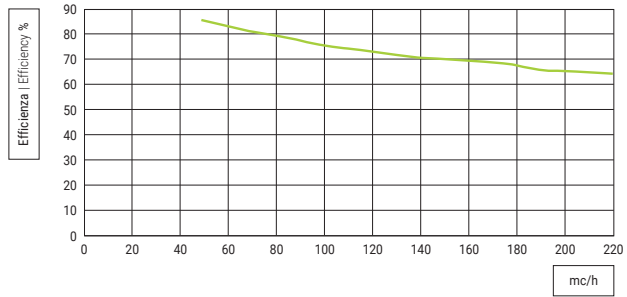
Fresh air: 35 °C - 57 % R.H.

Return air: 25 °C - 50 % R.H.

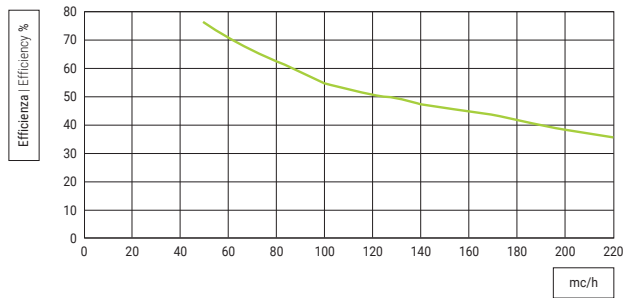

INSTALLAZIONE VERTICALE A PARETE | VERTICAL WALL INSTALLATION

Tipo | Type A (Standard)

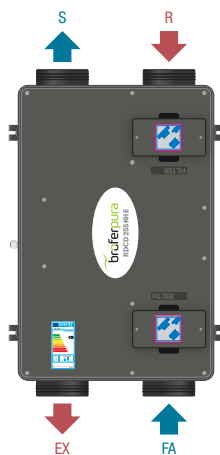

Tipo | Type B



INSTALLAZIONE ORIZZONTALE A SOFFITTO | HORIZONTAL CEILING INSTALLATION

Tipo | Type A (Standard)

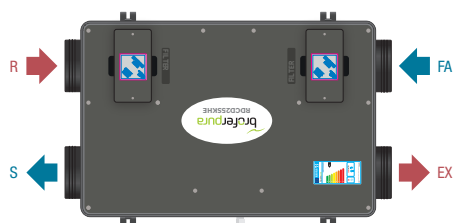

Tipo | Type A1 (Standard)

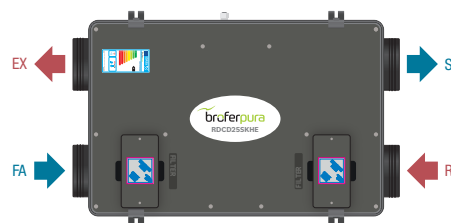

Tipo | Type B

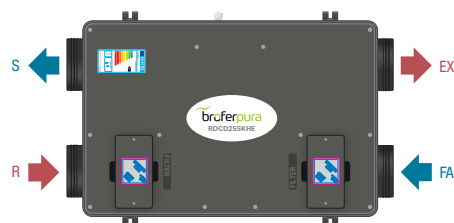

Tipo | Type B1

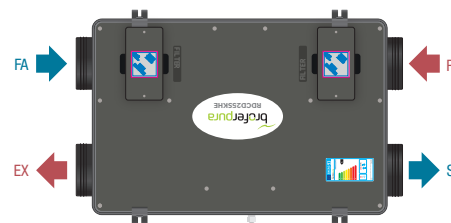

Legenda | Legend
 EX = espulsione | exhaust air
 R = ripresa | return
 FA = aria esterna | fresh air
 S = mandata | supply



DICHIARAZIONE DI PRESTAZIONE DELL'UNITÀ DI RECUPERO DEL CALORE
DECLARATION OF PERFORMANCE HEAT RECOVERY UNIT

Nome o denominazione commerciale del fabbricante Supplier name or trade mark	BROFER								
Identificativo del modello del fornitore e opzioni installate Supplier Model Identifier and options installed	RDCD25SKHE + 4BRF			RDCD25SKHE + RHRF / CO2RF			RDCD25SKHE + RHRF / CO2RF locali local		
Clima di riferimento Reference climate	Temperato Temperate	Freddo Cold	Caldo Hot	Temperato Temperate	Freddo Cold	Caldo Hot	Temperato Temperate	Freddo Cold	Caldo Hot
SEC in [kWh/(m²a)] per ogni tipo di clima (temperato, caldo, freddo) for each type of climate (temperate, hot, cold)	-30,22	-67,95	-8,61	-34,09	-73,19	-11,7	-38,63	-79,55	-15,19
SEC Class	B	A+	F	A	A+	E	A	A+	E
Tipologia dichiarata dell'unità di ventilazione Declared Typology	UVR-B Bidirezionale UVR-B Bidirectional			UVR-B Bidirezionale UVR-B Bidirectional			UVR-B Bidirezionale UVR-B Bidirectional		
Tipo di azionamento installato Type of drive installed	Azionamento a velocità multiple Multi-speed drive			Velocità variabile Variable speed			Velocità variabile Variable speed		
Tipo di sistema di recupero del calore Type of heat recovery	a recupero Recuperative			a recupero Recuperative			a recupero Recuperative		
Efficienza termica ¹ Thermal efficiency ¹	70%			70%			70%		
Portata massima in [m³/h] ² Maximum flow rate in [m³/h] ²	220			220			220		
Potenza elettrica complessiva massima portata [W] Maximum electric Power in [W]	114			114			114		
Livello di potenza sonora (LWA) in [dB(A)] ³ Sound Power Level (LWA) in [dB(A)] ³	50			50			50		
Portata di riferimento in [m³/h] ⁴ Reference flow rate [m³/h] ⁴	154			154			154		
Differenze di pressione di riferimento [Pa] Reference pressure difference in [Pa]	50			50			50		
SPI in [W/m³/h] ⁵	0,28			0,28			0,28		
Fattore di controllo e tipologia Control factor and typology	1			0,85			0,65		
Percentuale massima di trafilamento interno [%] ⁶ Declared maximum internal leakage [%] ⁶	0,7			0,7			0,7		
Percentuale massima di trafilamento esterno [%] ⁶ Declared maximum external leakage [%] ⁶	1,5			1,5			1,5		
Indirizzo Internet per istruzioni Internet address for pre/dis-assembly instruction	www.broferpura.it								

1: Efficienza in conformità a EN13141-7:2010 alla portata di riferimento a 50 Pa | Efficiency according EN13141-7:2010 at reference flow at 50 Pa
2: Portata massima a 100 Pa di pressione esterna | Maximum flow at 100 Pa external pressure
3: Irraggiamento dalla cassa alla portata di riferimento a 50 Pa di pressione esterna | Casing radiation at reference flow rate at 50 Pa external pressure
4: La percentuale della portata di riferimento è del 70% della portata massima a 50 Pa di pressione esterna in conformità a EN13141-7:2010
Reference flow rate is 70% of maximum flow at 50 Pa external pressure according EN13141-7:2010
5: In conformità a EN13141-7:2010 alla portata di riferimento | According EN13141-7:2010 at reference flow rate
6: In conformità a EN13141-7:2010 | According EN13141-7:2010
SEC: Consumo energetico specifico | Specific Energy Consumption









PREZZI | PRICES

Modello Model	Descrizione Description	€
RDCD25SKHE		
RDCD25SKHEBE*		
KFTR060A	Kit filtri ricambio (2 pz) efficienza G4 Replacement filter kit (2 pcs) efficiency G4	
FTR060C	Filtro ricambio efficienza F7 Replacement filter efficiency F7	

* Versione con batteria elettrica interna all'unità | Version with electric battery inside the unit

COMPOSIZIONE SISTEMI DI REGOLAZIONE | CONTROL SYSTEM COMPOSITION

	4BRF	RHRF	CO2RF	MODBUSRF	APPRF	DSPRF	TSMART
Modello Model							
Controllo velocità Speed control	•	•	•		•	•	•
By-pass						•	•
Intasamento filtri Clogged filters	•	•	•		•	•	•
Controllo umidità Humidity control		•					•
Controllo CO ₂ CO ₂ control			•				•
Funzione booster Booster function	•	•	•		•	•	•
Trasmittitore MODBUS MODBUS gate way				•			
Impostazione velocità Speeds setting		•	•			•	•
ON/OFF		•	•			•	•
Allarmi puntuali Punctual alarms	•	•	•			•	•
€	incluso nel prezzo included in the price						

Descrizione dettagliata comandi a pag. 15-16 | Detailed commands device description on page 15-16

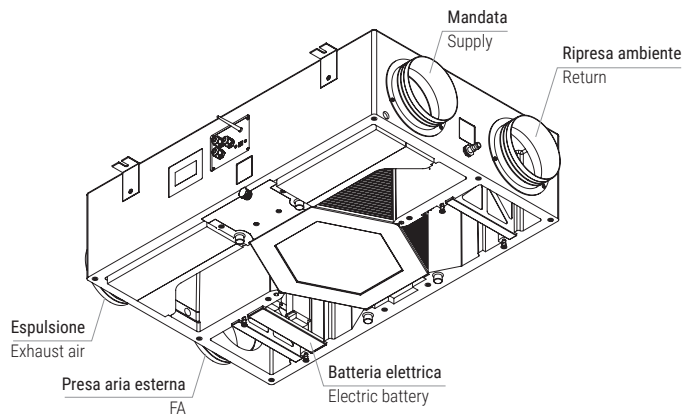

ACCESSORI | ACCESSORIES

**RDCD25SKHBE - RDCD25SKHEBE**

Batteria elettrica 1,5 kw - 230 V - 50 Hz integrata nell'unità | Electric battery 1,5 kw - 230 V - 50 Hz integrated in the unit
Batteria controllata dalla PCB dell'unità | Battery controlled by PCB of the unit
Sistema non fornibile dopo consegna unità | System not available after unit delivery

