

IONIC



ILH BERLIN
INSTITUT FÜR LUFTHYGIENE

ACCREDITIA
CENTRO ITALIANO DI ACCREDITAMENTO

IONIZADOR DE IONES NEGATIVOS

Características: módulo de higienización activa antibacteriana con ionización negativa sin formación de ozono. IONIC se basa en el principio del efecto corona, el fenómeno por el cual una corriente eléctrica fluye entre un conductor con un alto potencial a un fluido neutro circundante (aire). Este proceso crea la ionización negativa del aire sin crear un arco eléctrico. Al usar este dispositivo en el sistema de distribución de aire, se obtiene un efecto de reducción de las cargas microbianas, bacterianas y virales en las superficies de contacto.

Instalación: canales de aire metálicos de sección circular y cuadrangular. Centrales de tratamiento del aire.

NEGATIVE ION IONIZER

Characteristics: active antibacterial sanitization module with negative ionization without ozone formation. System based on the corona effect principle whereby an electric current flows between a high potential conductor and a surrounding neutral fluid (air). This process creates the negative ionization of the air without creating an electric arc. By using this device in the air distribution system, a reduction in microbial, bacterial and viral loads is achieved both in the air and on the contact surfaces of the system itself.

Installation: metal air ducts with circular and square section. Air handling units.

DESCRIPCIÓN DE LOS PARÁMETROS | PARAMETER DESCRIPTION

Tensión de alimentación Power supply voltage	230VDC \pm 5%
Máximo consumo eléctrico Maximum electrical absorption	3W
Tensión de salida Output voltage	-8 \div -10kV DC
Corriente de salida Output current	0,15mA
Protección de salida Output protection	Impedancia de 68M Ω
Emisión de iones Ion emissions	> 5.000.000 por cm ³ @ 100mm en modo estático (en la fase de ventilación se produce luego la propagación del aire) >5,000,000 per cm ³ @ 100mm statically (in the ventilation then propagation in air takes place)
Caudal máximo de aire Maximum air flow rate	2000 m ³ / h (por módulo individual) posibilidad de aumentar el flujo instalando más módulos en paralelo 2000 m ³ /h (per single module) possibility to increase the air flow rate by mounting several modules in parallel
Efecto de reducción de las cargas microbianas, bacterianas y virales en las superficies de contacto Effect of reducing the microbial, bacterial and viral load obtained on contact surfaces	



DISEÑOS | DRAWINGS

PESO | WEIGHT: 0,7 kg

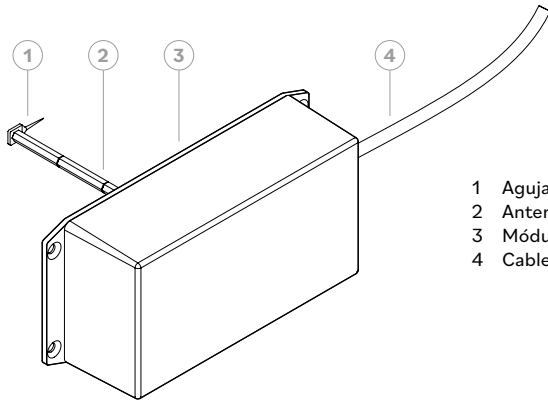

- 1 Aguja emisora | Emitter needle
- 2 Antena modular | Modular antenna
- 3 Módulo electrónico | Electronic unit
- 4 Cable de alimentación multinúcleo | Connection cable

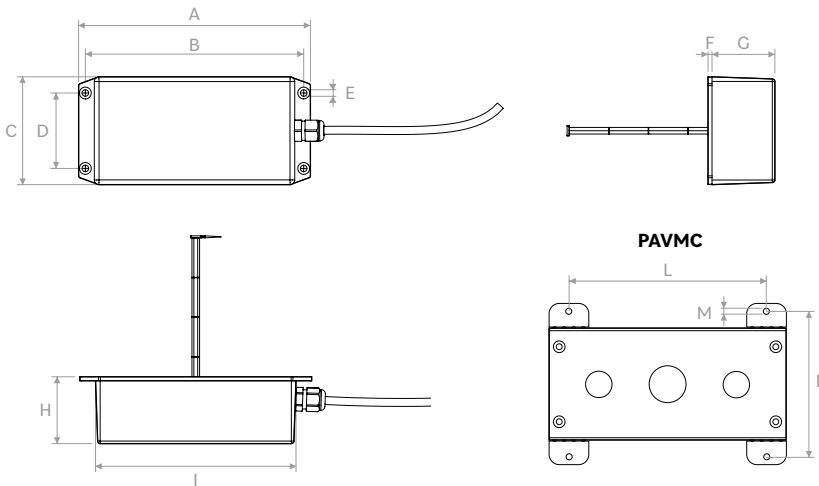

	A	B	C	D	E	F	G	H	I	L	M	N
mm	175	165	81	57	Ø 5	3	48	51	151,5	150	Ø 4,5	111

SANITIZATION

EMISIÓN DE IONES EN EL CANAL | ION EMISSIONS IN THE DUCT

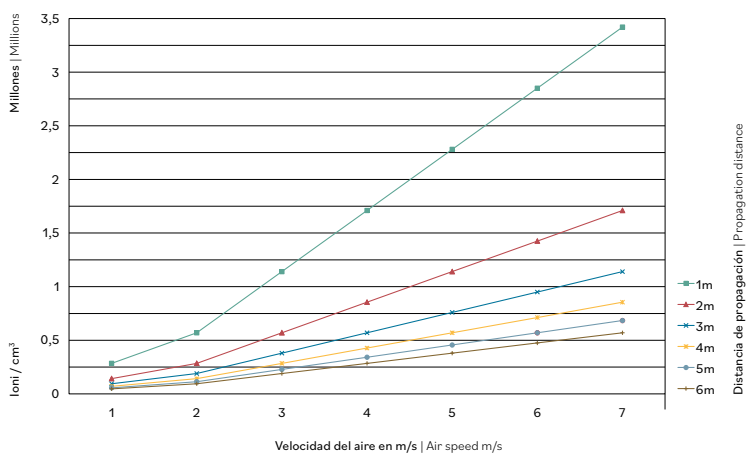

IONIC

POSICIÓN Y DIMENSIONES TOTALES | POSITIONING AND DIMENSIONS

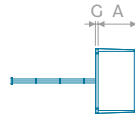
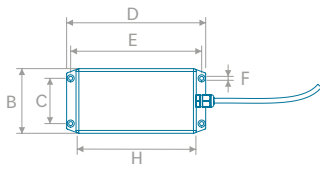

	A	B	C	D	E	ØF	G	H
mm	48	81	57	175	165	5	3	151

RDCD25I

	B	X
mm	81	82

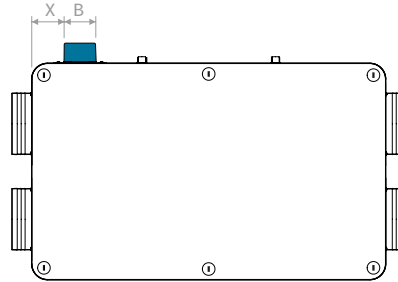

RDCD25SKI

	B	Y
mm	81	250

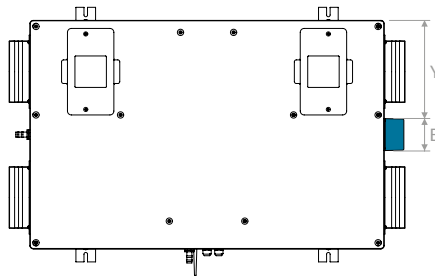

RDCD25SKCI

	B	Y
mm	81	257

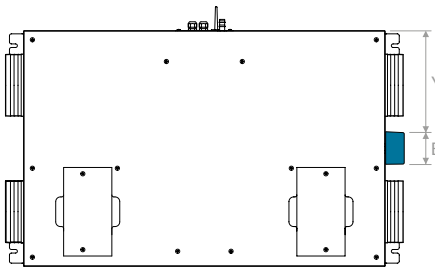

RDCD25SKHI

	B	Y
mm	81	250

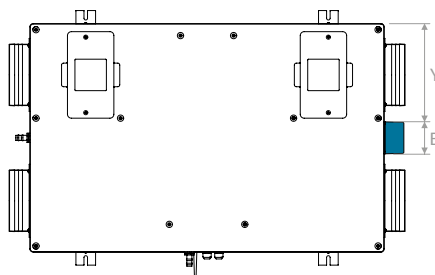

POSICIÓN Y DIMENSIONES TOTALES | POSITIONING AND DIMENSIONS

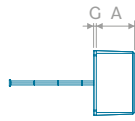
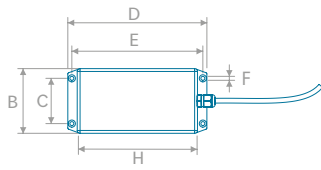

	A	B	C	D	E	ØF	G	H
mm	48	81	57	175	165	5	3	151

RDCD25SKHCI

	B	Y
mm	81	257

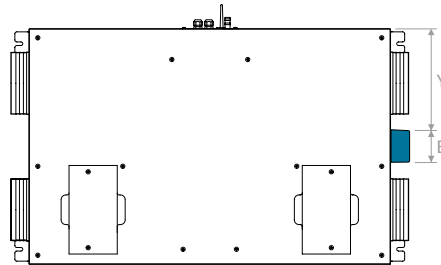

RDCD30SHI

	X	Y	B	H
mm	162	218	81	151

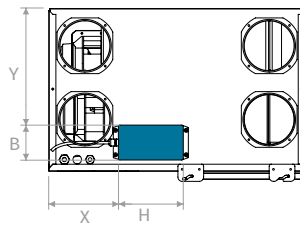

RDCD40SKI

	H	X
mm	151	340

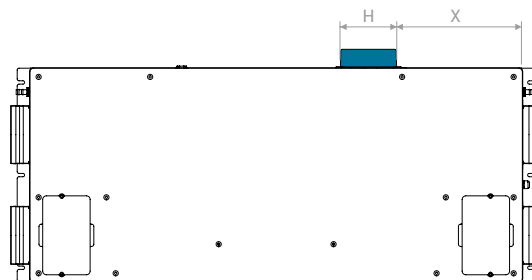

RDCD40SKCI

	H	X
mm	151	350

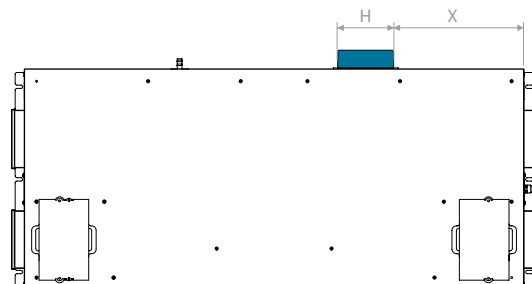

IONIC

POSICIÓN Y DIMENSIONES TOTALES | POSITIONING AND DIMENSIONS

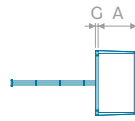
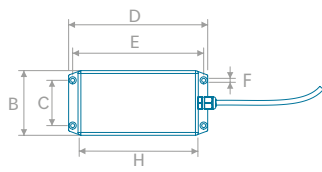

	A	B	C	D	E	ØF	G	H
mm	48	81	57	175	165	5	3	151

RDCD50SHI / RDCD70SHI

	X	Y	B	H
mm	201	184	81	151

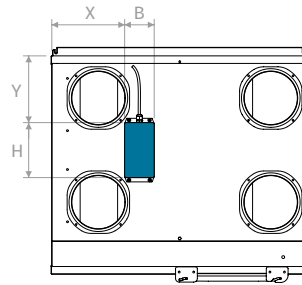

RDCD300HCI

	Y	B
mm	332	81

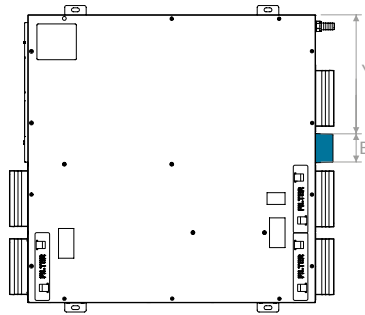

RDCD300HCHI

	Y	B
mm	332	81

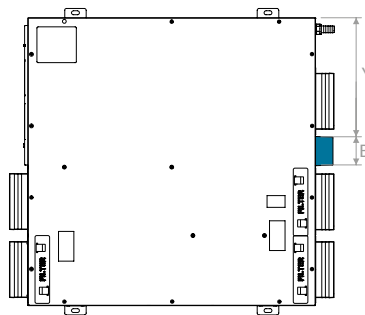

RDCD500HCHI

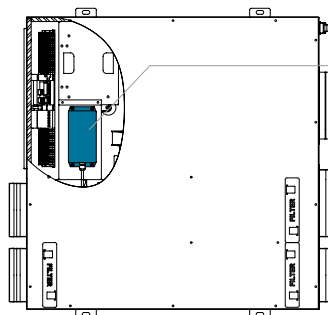

IONIC instalado internamente.
Sin dimensiones exteriores.
IONIC installed internally.
No external encuni encumbrance.



POSICIÓN Y DIMENSIONES TOTALES | POSITIONING AND DIMENSIONS

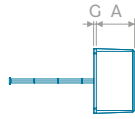
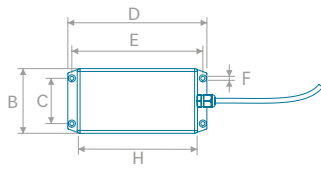

	A	B	C	D	E	ØF	G	H
mm	48	81	57	175	165	5	3	151

RDCD50SKI

	H	X
mm	151	340

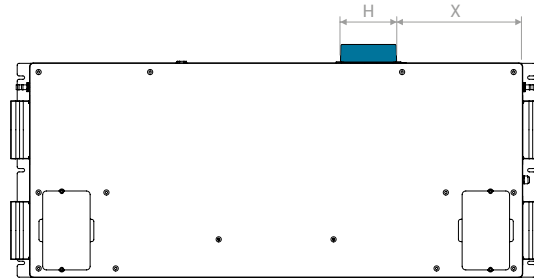

RDCD50SKCI

	H	X
mm	151	350

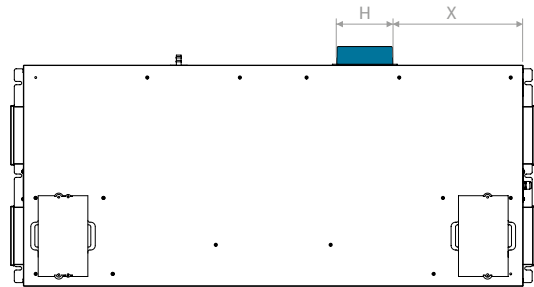

PLUGPVMCSH6I

	X	H
mm	140	151

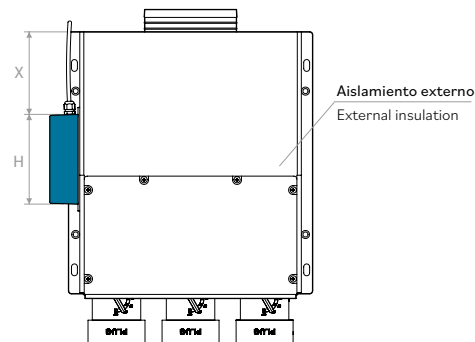

PLUGPVMCSH10I

	X	H
mm	140	151

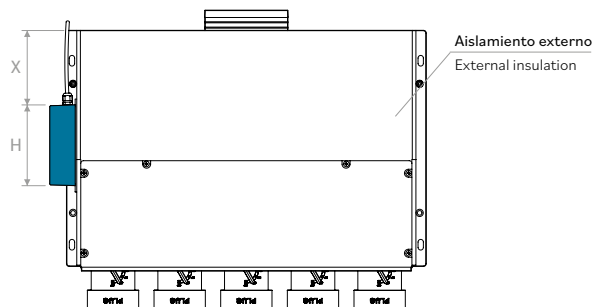

SANITIZATION

IONIC

POSICIÓN Y DIMENSIONES TOTALES | POSITIONING AND DIMENSIONS

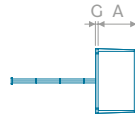
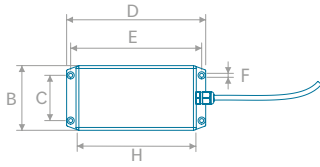

	A	B	C	D	E	ØF	G	H
mm	48	81	57	175	165	5	3	151

PLUGPVMCMRI

	X	B
mm	110	81

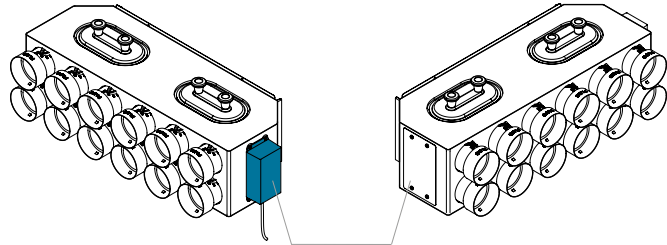
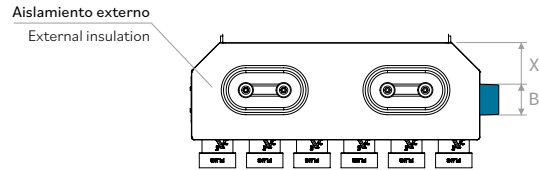

Posibilidad de invertir la posición del módulo IONIC en función de la configuración de los flujos de salida / retorno
 Possibility of inverting the position of the IONIC module based on the configuration of the supply/return flow



CÓDIGOS | CODES

Modelo | Model

IONIC

PAVMC*

KIONICDUCT (IONIC+PAVMC)

* Soporte para instalación
Mounting bracket

