



# RDCD50SH



Scheda tecnica  
Data sheet



## UNITÀ DI RECUPERO CALORE DOMESTICA CENTRALIZZATA AD ALTISSIMA EFFICIENZA REGOLAZIONE PLUG AND PLAY WIRELESS INCLUSA BY-PASS AUTOMATICO INCLUSO

**Recuperatore di calore:** in controcorrente interamente realizzato in materiale plastico.

**Struttura:** autoportante in EPS a tenuta con mantello esterno in acciaio completa di sistema estrazione filtri e drenaggio condensa.

**Ventilatori:** plug fan con motori EC Brushless.

**Filtri:** le unità sono provviste di serie con celle filtranti ondulate in fibra sintetica classe G4, in opzione filtro efficienza F7 su aria esterna.

## DOMESTIC CENTRALIZED HEAT RECOVERY UNIT WITH VERY HIGH EFFICIENCY WIRELESS PLUG AND PLAY CONTROL SYSTEM INCLUDED AUTOMATIC BY-PASS INCLUDED

**Heat recovery:** heat exchanger of the type in countercurrent entirely made of plastic material.

**Structure:** free standing EPS seal with outer coat painted steel complete of filters extraction system and drain condensate.

**Fans:** plug fan type with EC Brushless engine.

**Filters:** the units are equipped with standard filter cells synthetic fiber efficiency G4, optional F7 efficiency on fresh air.

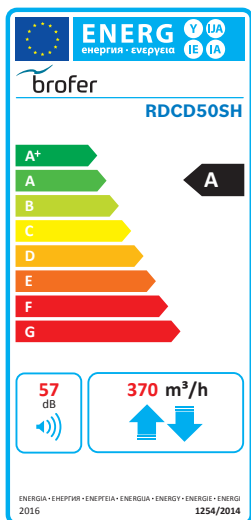

Portata aria (mc/h)   Nominal air flow (mc/h)	370
Pressione statica utile (pa)   Useful static pressure (pa)	100

### DATI PER SINGOLO VENTILATORE | DATA FOR EACH FAN

Potenza nominale (w)   Installed power (W)	83
I nominale (A)   Current (A)	0,75
Tensione (V)   Rated voltage (V)	230
Frequenza (Hz)   Frequency (HZ)	50
Velocità (nr)   Speed (nr)	3+(1 booster)

### FILTRI | FILTERS

Efficienza   Efficiency Standard	G4 ISO COARSE > 65 %
Efficienza   Efficiency Optional	F7 ISO e PM1 > 65 %



PESO | WEIGHT: 41 kg

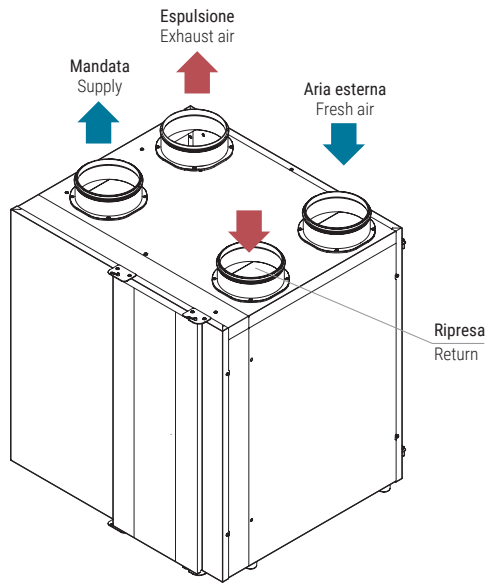

Vista frontale | Front view

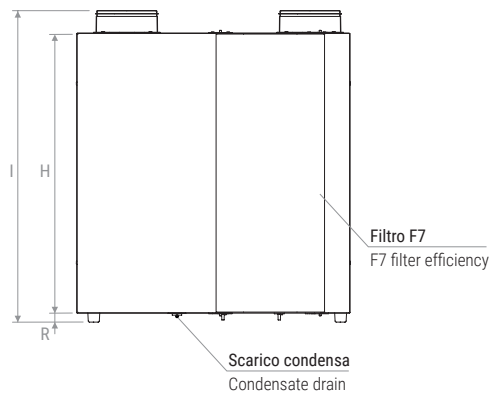

Vista laterale | Side view

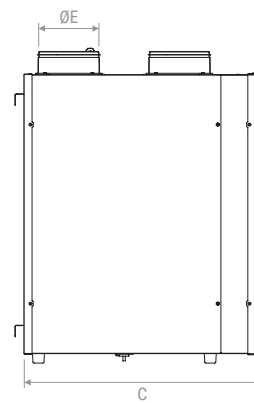

Vista superiore | Top view

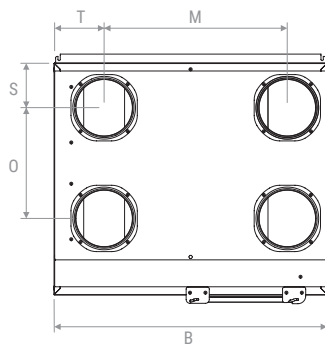

	B	C	H	ØE	I	M	O	R	S	T
mm	702	617	722	160	808	475	287	24	199	128



PRESTAZIONI CERTIFICATE EN 13141:7:2011 | PERFORMANCE EN 13141:7:2011 CERTIFIED

**Pressione statica utile**  
Useful static pressure  
① ③

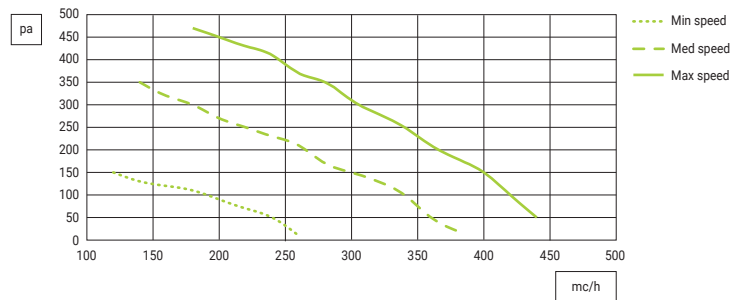

**Potenza specifica ventilatore**  
S.F.P.  
②

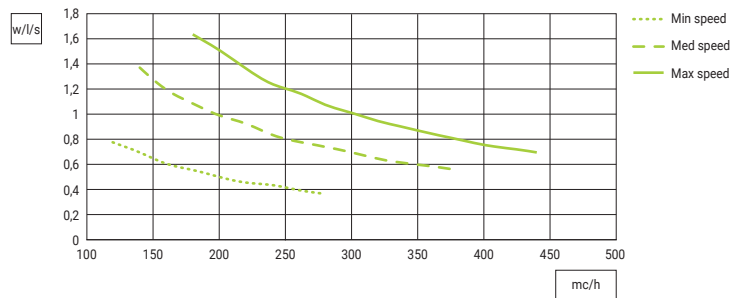

SCAMBIATORE CERTIFICATO EN 13147:7:2011 | HEAT EXCHANGER EN 13147:7:2011 CERTIFIED

**Diagramma efficienza estiva**  
Aria esterna: 32 °C / 50 % U.R.  
Aria ambiente: 26 °C / 50 % U.R.  
Summer efficiency chart  
Fresh air: 32 °C / 50 % R.H.  
Return air: 26 °C / 50 % R.H.

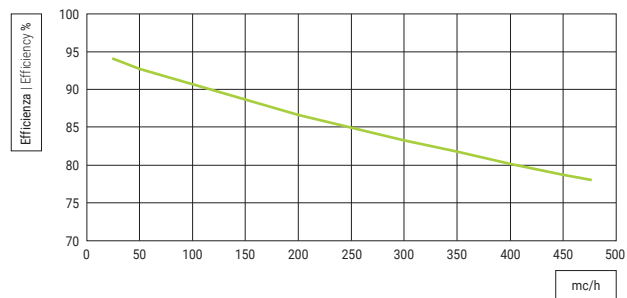

**Diagramma efficienza invernale**  
Aria esterna: -5 °C / 80 % U.R.  
Aria ambiente: 20 °C / 50 % U.R.  
Winter efficiency chart  
Fresh air: -5 °C / 80 % R.H.  
Return air: 20 °C / 50 % R.H.

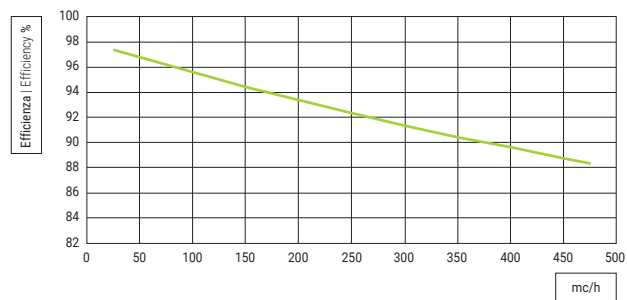

- ① Dati con filtri G4 standard | Data with standard G4 filters
- ② Dati per singolo ventilatore | Data for single fan
- ③ Perdite di carico filtro efficienza F7 80 pa alla massima portata con filtro pulito  
Air pressure drop with F7 efficiency filter 80 pa at maximum air flow rate with clean filter



## LIVELLO SONORO IRRAGGIATO | RADIATED SOUND LEVEL

VELOCITÀ   SPEED		PRESSIONE SONORA   SOUND PRESSURE							
Hz	63	125	250	500	1000	2000	4000	8000	
10V	24	30	48	52	50	47	41	40	dB (A)
8V	21	32	47	51	47	45	39	37	dB (A)
6V	21	28	46	45	38	38	32	27	dB (A)



# RDCD50SH

## DICHIARAZIONE DI PRESTAZIONE DELL'UNITÀ DI RECUPERO DEL CALORE DECLARATION OF PERFORMANCE HEAT RECOVERY UNIT

Nome o denominazione commerciale del fabbricante Supplier name or trade mark	BROFER								
Identificativo del modello del fornitore e opzioni installate Supplier Model Identifier and options installed	RDCD50SH + 4BRF			RDCD50SH + RHRF / CO2RF			RDCD50SH + RHRF / CO2RF locali   local		
Clima di riferimento Reference climate	Temperato Temperate	Freddo Cold	Caldo Hot	Temperato Temperate	Freddo Cold	Caldo Hot	Temperato Temperate	Freddo Cold	Caldo Hot
SEC in [kWh/(m <sup>2</sup> a)] per ogni tipo di clima (temperato, caldo, freddo) for each type of climate (temperate, hot, cold)	-37,41	-76	-12,67	-40,12	-79,15	-15,14	-43,16	-82,77	-17,74
SEC Class	A	A+	F	A	A+	F	A	A+	E
Tipologia dichiarata dell'unità di ventilazione Declared Typology	UVR-B Bidirezionale UVR-B Bidirectional			UVR-B Bidirezionale UVR-B Bidirectional			UVR-B Bidirezionale UVR-B Bidirectional		
Tipo di azionamento installato Type of drive installed	Velocità variabile Variable speed			Velocità variabile Variable speed			Velocità variabile Variable speed		
Tipo di sistema di recupero del calore Type of heat recovery	a recupero Recuperative			a recupero Recuperative			a recupero Recuperative		
Efficienza termica <sup>1</sup> Thermal efficiency <sup>1</sup>	90,5%			90,5%			90,5%		
Portata massima in [m <sup>3</sup> /h] <sup>2</sup> Maximum flow rate in [m <sup>3</sup> /h] <sup>2</sup>	370			370			370		
Potenza elettrica complessiva massima portata [W] Maximum electric Power in [W]	169			169			169		
Livello di potenza sonora (LWA) in [dB(A)] <sup>3</sup> Sound Power Level (LWA) in [dB(A)] <sup>3</sup>	57,3			57,3			57,3		
Portata di riferimento in [m <sup>3</sup> /h] <sup>4</sup> Reference flow rate [m <sup>3</sup> /h] <sup>4</sup>	259			259			259		
Differenze di pressione di riferimento [Pa] Reference pressure difference in [Pa]	50			50			50		
SPI in [W/m <sup>3</sup> /h] <sup>5</sup>	0,259			0,259			0,259		
Fattore di controllo e tipologia Control factor and typology	1			0,85			0,65		
Percentuale massima di trafilamento interno [%] <sup>6</sup> Declared maximum internal leakage [%] <sup>6</sup>	0,3			0,3			0,3		
Percentuale massima di trafilamento esterno [%] <sup>6</sup> Declared maximum external leakage [%] <sup>6</sup>	0,4			0,4			0,4		
SEC Clima temperato (kWh energia elettrica/anno) SEC Temperate climate (kWh electricity/annum)	359			272			178		
AHS (kWh energia primaria/anno) AHS (kWh primary energy/annum)	4.598	8.995	2.079	4.653	9.083	2.100	4.704	9.202	2.127
Indirizzo Internet per istruzioni Internet address for pre/dis-assembly instruction	www.broferpura.it								

- 1: Efficienza in conformità a EN13141-7:2010 alla portata di riferimento a 50 Pa | Efficiency according EN13141-7:2010 at reference flow at 50 Pa  
 2: Portata massima a 100 Pa di pressione esterna | Maximum flow at 100 Pa external pressure  
 3: Irraggiamento dalla cassa alla portata di riferimento a 50 Pa di pressione esterna | Casing radiation at reference flow rate at 50 Pa external pressure  
 4: La percentuale della portata di riferimento è del 70% della portata massima a 50 Pa di pressione esterna in conformità a EN13141-7:2010  
 Reference flow rate is 70% of maximum flow at 50 Pa external pressure according EN13141-7:2010  
 5: In conformità a EN13141-7:2010 alla portata di riferimento | According EN13141-7:2010 at reference flow rate  
 6: In conformità a EN13141-7:2010 | According EN13141-7:2010  
 SEC: Consumo energetico specifico | Specific Energy Consumption









PREZZI | PRICES

Modello   Model	Descrizione   Description	€
<b>RDCD50SH</b>		
<b>RDCD50SHE*</b>		
<b>FTRSV23</b>	Kit filtri ricambio (2 pz) efficienza G4   Replacement filter kit (2 pcs) efficiency G4	
<b>FTRSV48</b>	Filtro ricambio efficienza F7   Replacement filter efficiency F7	

\* Versione con recuperatore entalpico | Version with enthalpic heat exchanger

COMPOSIZIONE SISTEMI DI REGOLAZIONE | CONTROL SYSTEM COMPOSITION

	4BRF	RHRF	CO2RF	MODBUSRF	APPRF	DSPRF	TSMART
Modello Model							
Controllo velocità Speed control	•	•	•		•	•	•
By-pass						•	•
Intasamento filtri Clogged filters	•	•	•		•	•	•
Controllo umidità Humidity control		•					•
Controllo CO <sub>2</sub> CO <sub>2</sub> control			•				•
Funzione booster Booster function	•	•	•		•	•	•
Trasmittitore MODBUS MODBUS gate way				•			
Impostazione velocità Speeds setting		•	•			•	•
ON/OFF		•	•			•	•
Allarmi puntuali Punctual alarms	•	•	•			•	•
€	incluso nel prezzo included in the price						

Descrizione dettagliata comandi a pag. 15-16 | Detailed commands device description on page 15-16

