

VMCS1200

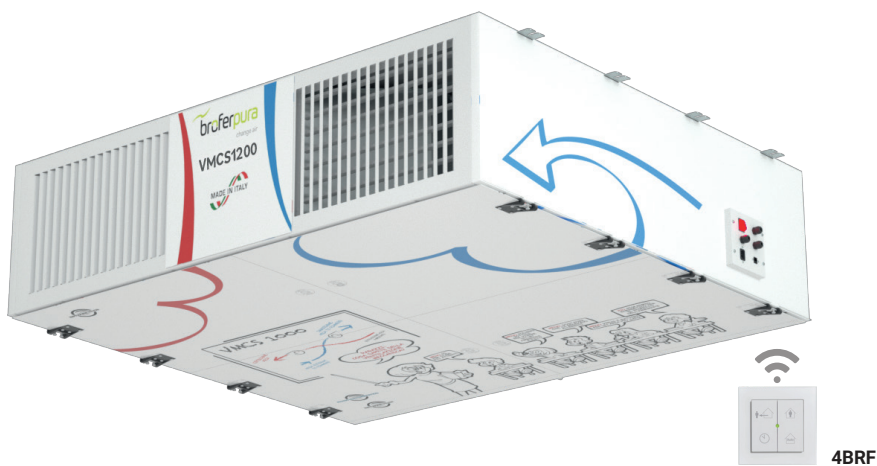

Scheda tecnica
Data sheet

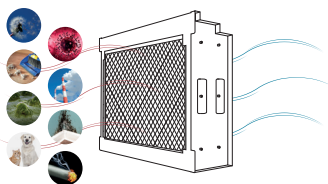

Filtro elettronico (optional)
efficienza UNI 11254 e PM 2,5 90/95%
Electronic filter (optional)
efficiency UNI 11254 and PM 2,5 90/95%



UNITÀ DECENTRALIZZATA VMC AD ALTISSIMA EFFICIENZA

Recuperatore di calore: scambiatore del tipo in controcorrente in materiale plastico ad altissima efficienza. Completo di bypass automatico e vasca raccolta condensa.

Struttura: a sandwich afonizzata autoportante. Provvista di pannelli asportabili per le operazioni di manutenzione ordinaria e straordinaria. Completa di staffe per il fissaggio a soffitto.

Ventilatori: centrifughi a doppia aspirazione con motore elettrico EC brushless direttamente accoppiato con funzionamento a portata costante.

Filtri: efficienza G4 su ripresa ambiente. Efficienza M5 su presa aria esterna.

Optional:

- Controllo CO₂ (CO2RF).
- Filtro efficienza F7 (VMCS1200 F7).
- Modulo comunicazione modbus (MODBUSRF).

DECENTRALIZED VMC HEAT RECOVERY UNIT WITH VERY HIGH EFFICIENCY

Heat recovery: high efficiency plastic counter-current exchanger. Complete with automatic bypass and condensate collection basin.

Structure: self-supporting soundproof sandwich structure. Equipped with removable panels for ordinary and extraordinary maintenance operations. Complete with brackets for ceiling fixing.

Fans: double inlet centrifugal fans with directly coupled brushless EC electric motor with constant flow operation.

Filters: G4 efficiency on return air. M5 efficiency on fresh air.

Optional:

- CO₂ control (CO2RF).
- F7 efficiency filter (VMCS1200 F7).
- Modbus communication device (MODBUSRF).

VMCS1200 - VMCS1200FE

Portata aria rinnovo Replacement airflow	1200 mc/h
Portata aria estrazione Extraction airflow	1200 mc/h
Efficienza recupero termico* Thermal recovery efficiency*	85 %
Potenza nominale singolo ventilatore (w) Installed power single fan (w)	350
Filtrazione aria rinnovo Replacement air filtration	M5 ISO COARSE ≥ 70 %
Filtrazione aria estrazione Extraction air filtration	G4 ISO COARSE ≥ 65 %
Filtrazione aria rinnovo (opzionale) Replacement air filtration (optional)	F7 ISO e PM1 ≥ 65 %
Filtrazione elettronica Electronic filtration	Opzionale Optional
Controllo CO ₂ CO ₂ control	Opzionale Optional

* (UNI EN 308) aria rinnovo: 5°C 72% UR / aria espulsione: 25°C 28% UR
(UNI EN 308) fresh air: 5 ° C 72% RH / expulsion air: 25 ° C 28% RH



PESO | WEIGHT: 220 kg

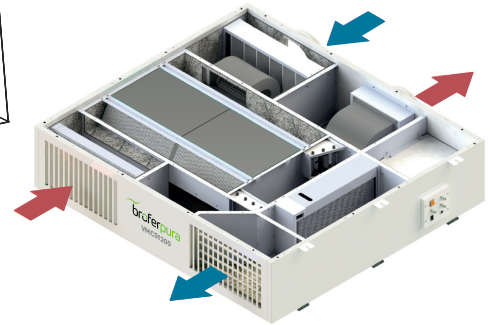
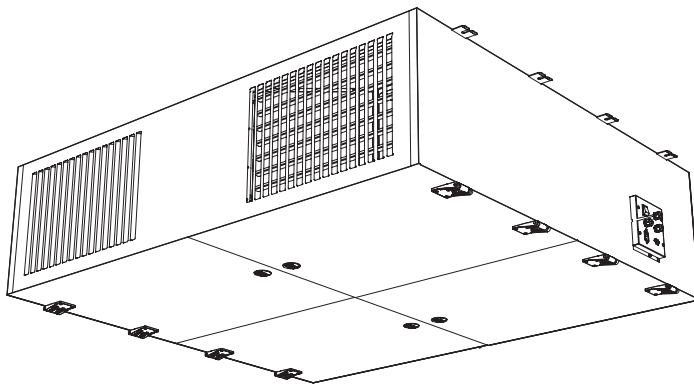

Vista dal basso | Bottom View

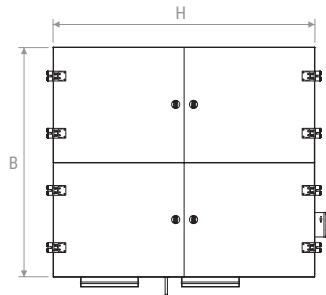

Vista laterale DX | Side view right

Vista frontale | Front view

Vista laterale SX | Side view left

Vista posteriore | Rear view

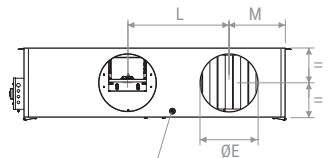
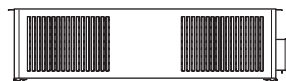

Ingresso alimentazione | Power supply input
 Ingresso controller | Controller input
 Pulsante accensione | Power button

Porte ispezione
 Inspection doors

Scarico condensa | Condensate drain
 Tubo vitreo Ø20 | Vitreous pipe Ø20

Vista dall'alto | Top view

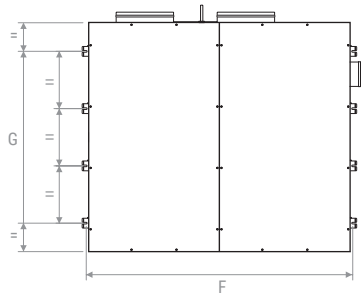

	B	H	C	ØE	F	G	L	M
mm	1400	1600	426	355	1628	1050	623	344



SCAMBIATORE CERTIFICATO EN 308 | HEAT EXCHANGER EN 308 CERTIFIED

Diagramma efficienza estiva

Aria esterna: 32 °C / 50 % U.R.
 Aria ambiente: 26 °C / 50 % U.R.
Summer efficiency chart
 Fresh air: 32 °C / 50 % R.H.
 Return air: 26 °C / 50 % R.H.



Diagramma efficienza invernale

Aria esterna: -5 °C / 80 % U.R.
 Aria ambiente: 20 °C / 50 % U.R.
Winter efficiency chart
 Fresh air: -5 °C / 80 % R.H.
 Return air: 20 °C / 50 % R.H.

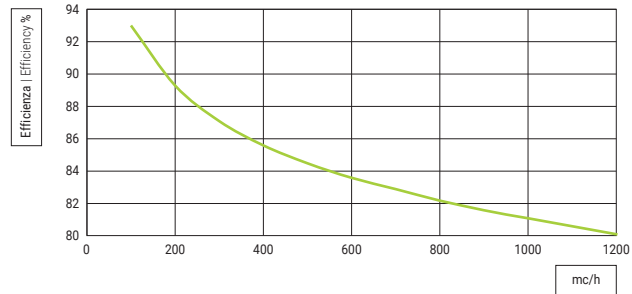
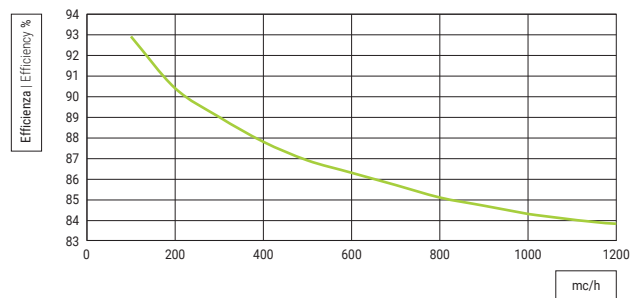

DATI ACUSTICI RELATIVI A POTENZA SONORA IRRAGGIATA DALLA STRUTTURA ACOUSTIC DATA RELATIVE TO THE SOUND POWER RADIATED BY THE CASING

	Portata aria Air flow rate		Frequenza Frequency								
	mc/h		Hz								
			63	125	250	500	1000	2000	4000	8000	
Velocità alta High speed	1270		46,5	54	56	52,5	59	57	47	40,5	dB
Velocità media Medium speed	910		42,5	47	46,5	45,5	53	51,5	39	32	dB
Velocità bassa Low speed	740		39	43,5	43,5	42	49	45,5	34	27	dB

DATI ECODESIGN | ECODESIGN DATA SHET







Modello Model	Efficienza Efficiency	Portata aria nominale Nominal air flow rate	Pressione statica utile Useful static pressure	SFPInt	SFP-2018	Velocità frontale Front speed	Efficienza ventilatore Fan Efficiency	Leakage interno Internal leakage	Leakage esterno External leakage
	%	mc/h	pa	w/m³/s	w/m³/s	m/s	%	%	%
VMCS1200	79,4	850	250	1341	1436	1,44	53	4,5	5,2



PREZZI | PRICES

Modello Model	€
VMCS1200 Versione standard Standard version	
VMCS1200FE Versione con filtro elettronico Version with electronic filter	
VMCS1200G4 Filtro efficienza G4 (ricambio) Filter G4 efficiency (spare part)	
VMCS1200M5 Filtro efficienza M5 (ricambio) Filter M5 efficiency (spare part)	
VMCS1200F7 Filtro efficienza F7 per aria rinnovo F7 efficiency filter for replacement air	



COMPOSIZIONE SISTEMI DI REGOLAZIONE | CONTROL SYSTEM COMPOSITION

	4BRF	RHRF	CO2RF	MODBUSRF	APPRF	DSPRF	TSMART
Modello Model							
Controllo velocità Speed control	•	•	•		•	•	•
By-pass						•	•
Intasamento filtri Clogged filters	•	•	•		•	•	•
Controllo umidità Humidity control		•					•
Controllo CO ₂ CO ₂ control			•				•
Funzione booster Booster function	•	•	•		•	•	•
Trasmettitore MODBUS MODBUS gate way				•			
Impostazione velocità Speeds setting		•	•			•	•
ON/OFF		•	•			•	•
Allarmi puntuali Punctual alarms	•	•	•			•	•
€	incluso nel prezzo included in the price						



VMCS1200

ACCESSORI | ACCESSORIES

Modello Model		€
NMC161200	 <p>Modulo compatto di espulsione presa aria di rinnovo in lamiera zincata verniciata RAL 9016 Compact module exhaust fresh air galvanized steel RAL 9016 painted</p>	
RAVMCS1200	 <p>Silenziatore circolare senza ogiva in lamiera zincata Circular sound attenuator with out ogive in galvanized steel</p>	RAVMCS1200250 (250 mm)
		RAVMCS1200500 (500 mm)
		RAVMCS1200750 (750 mm)
		RAVMCS12001000 (1000 mm)

APPLICAZIONI | APPLICATIONS

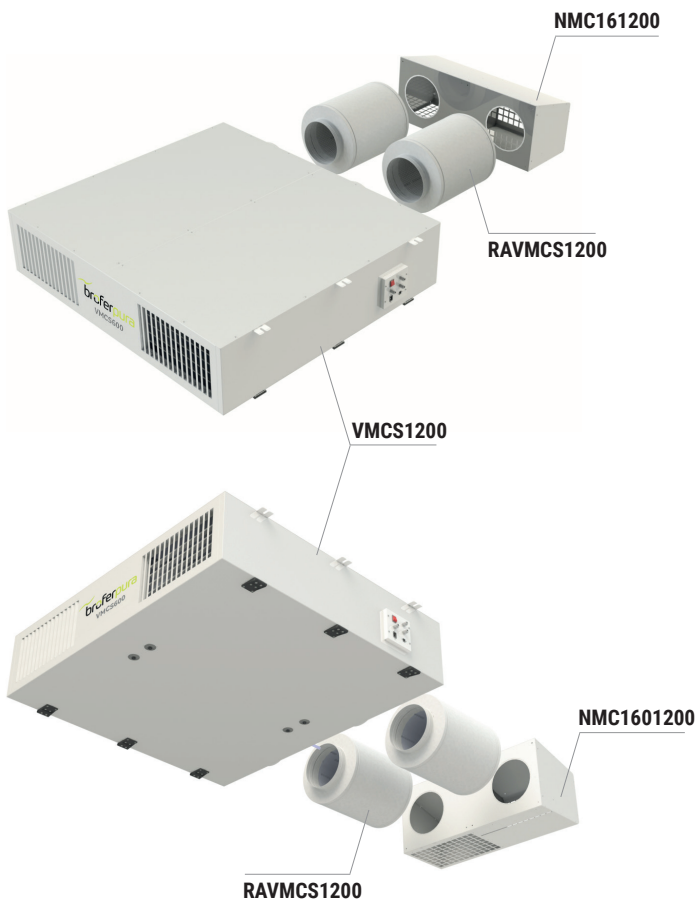

DISEGNI | DRAWINGS

NMC161200

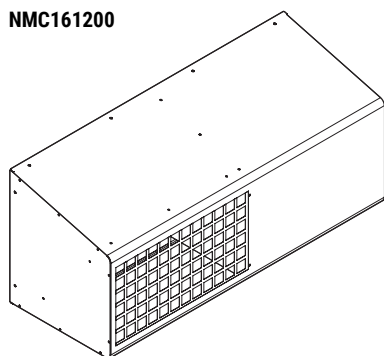

Vista dal basso | Bottom View

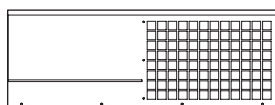

Vista frontale | Front View

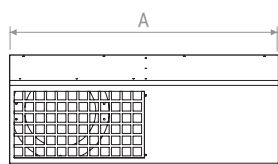

Vista laterale | Side View

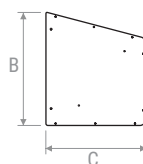

Vista posteriore | Rear View

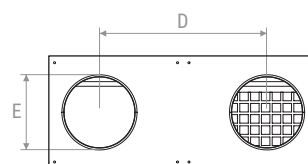

Vano di espulsione
Exhaust air compartment

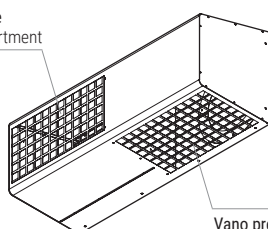

Vano presa aria esterna
Fresh air compartment

Canali di uscita del muro
Ducts coming out of the wall

Ghigliottine per adattamento
circonferenza dei canali
Ghillottines for circumference
adaption of the ducts

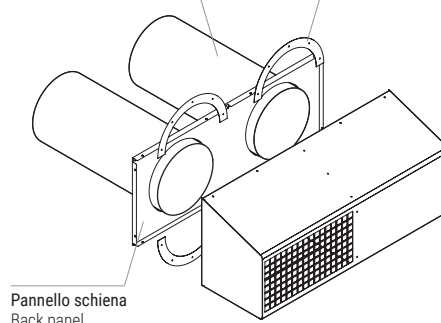

	A	B	C	D	E
mm	1200	490	390	618	Ø 365

RAVMCS

Interno | Internal

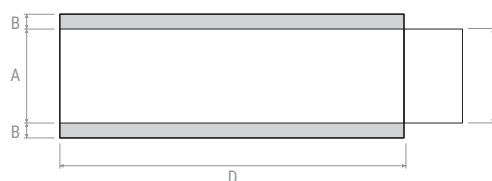

Esterno | External

	A	B	C	D
mm	355	50	353	250 / 500 / 750 / 1000

